

# Digi-Wave® 400 Series

Digital Transceiver and Receiver

USER MANUAL



## Contents

---

Safety Warnings and Recycling Instructions .....	3
System Overview .....	4
DLR 400 ALK Differences.....	4
DLT 400 Controls and Connectors.....	5
DLR 400 RCH Controls and Connectors.....	5
General Operation .....	6
Before Programming the Digi-Wave™ System .....	7
The Main Screen .....	9
Setting Up the Digi-Wave™ System.....	10
Language.....	10
Initial Setup .....	10
Changing Settings.....	11
Basic Settings .....	11
Advanced Settings .....	11
Interpretation Mode Features.....	14
Floor and Interpreter .....	15
Repeater Broadcast Mode.....	15
Standard Interpretation Mode.....	15
Bilingual Mode.....	16
Relay Mode .....	17
Court Mode.....	18
Saving and Replacing Profiles.....	19
Differences between DLT 400, DLT 400-AIM, DLT 400-ACM .....	19
Updating DLT 400 and DLR 400 RCH Firmware.....	20
Advanced Interpretation Module.....	21
Interpretation Q&A Mode .....	21
24-Channel Interpretation Mode.....	36
Control Function.....	39
Channel Naming .....	39
Channel Sub-Groups .....	41
Advanced Comms Module (ACM).....	45
Advanced Comms Module (ACM) Overview .....	45
Advanced Comms Mode .....	46
Subgroup Naming .....	54
Troubleshooting .....	59
Specifications - DLT 400, DLT 400-AIM, & DLT 400-ACM Transceiver.....	60
Specifications - DLR 400 RCH Receiver.....	61
Specifications - DLR 400 ALK Receiver.....	62
Regulatory Statements.....	63
2-Year Warranty.....	65

# Safety Warnings and Recycling Instructions

## HEARING SAFETY

### CAUTION!

This product is designed to amplify sounds to a high volume level which could potentially cause hearing damage if used improperly. To protect your hearing and the hearing of others:

1. Turn the volume down before putting on the earphone or headphone, and then adjust the volume to a comfortable level,
2. Set the volume level at the minimum setting that you need to hear,
3. If you experience feedback (a squealing or howling sound), reduce the volume setting and move the microphone away from the earphone or headphone.
4. Do not allow children or other unauthorized persons to have access to this product

## MEDICAL DEVICE SAFETY

### CAUTION!

1. Before using this product with an implantable or other medical device, consult your physician or the manufacturer of your implantable or other medical device.
2. If you have a pacemaker or other medical device, make sure that you are using this product in accordance with safety guidelines established by your physician or the implantable device manufacturer.

## BATTERY SAFETY

### CAUTION!

#### **DLT 400 and DLR 400 RCH internal battery pack.**

To reduce the risk of fire or burns, do not attempt to open, disassemble, or service the battery pack. Do not crush, puncture, short contacts or dispose of in fire or water. Do not incinerate or expose to temperatures above 140°F (60°C). Replace only with battery pack designated for this product: a rechargeable Lithium-polymer battery. Recycle or dispose of properly.

### CAUTION!

The lithium batteries used in the DLT 400 and DLR 400 RCH provide great performance and long life. But, like all lithium batteries, they do have a limited number of charge/discharge cycles. Lithium batteries may experience swelling if used beyond their expected life cycle (2 years). If you notice swelling of the battery, please discontinue use and have the battery replaced. We recommend battery replacement after 2 years of use. For more information about replacing the battery, please visit our website at:

<http://www.williamsav.com/digiwave-battery-replacement>.



## RECYCLING INSTRUCTIONS



### **Battery Safety and Disposal**

Help Williams AV protect the environment! Please take time to dispose of your equipment properly. Please do NOT dispose of batteries in the household trash. Please take the batteries to a retail or community collection point for recycling.

### **Product Recycling:**

Please do NOT dispose of your Williams AV equipment in the household trash. Please take the equipment to an electronics recycling center or return the product to the factory for proper disposal.

## System Overview

---

The Digi-Wave communication system allows users to listen and talk to one another wirelessly in a variety of scenarios. A Digi-Wave system consists of at least one transceiver (DLT 400) and various combinations of transceivers and receivers (DLR 400).

The DLT 400 is a two-way transceiver, meaning that it can transmit and receive audio simultaneously.

The DLR 400 is a receiver only. Users of DLR 400 receivers can only hear what is being broadcast by DLT(s); they cannot create any audio. There are two models of DLR: the DLR 400 ALK and the DLR 400 RCH. For information on the differences, see “DLR 400 ALK Differences” on page 4.

For simplicity, throughout the rest of this manual, the DLT 400 may be referred to as a “DLT.” The DLR 400 RCH and DLR 400 ALK as a “DLR” when the behavior of both devices is the same.

Combinations of one or more DLT’s and DLR’s can be used to facilitate different events, depending on what needs to be spoken and what needs to be heard. Examples of scenarios will be covered here.

### Typical Scenarios include:

- Guided Tours - with one or more tour guides (2-way), with audience participation (2-way), or without audience participation (1-way)
- Language Interpretation - one or more interpreted languages transmitted to audience (1-way)
- Intercom - with up to six people able to speak simultaneously (2-way)

There are many more scenarios than are covered in this manual, however these would be variations on the ones discussed here.

### Backwards Compatibility

The Digi-Wave 400 Series is backward compatible with the 300 series with limited features.

It is **not** backward compatible with any earlier transceivers or receivers (DLT 100, DLT 100 2.0, DLR 50, DLR 60, and DLR 60 2.0).

### The Technology

The Digi-Wave™ system is a digital spread-spectrum (DSS), simultaneous two-way wireless listening system operating in the 2.4 GHz band. Due to its frequency-hopping algorithm, it avoids interference and is a very secure method of communication. For a more detailed explanation of how Digi-Wave technology works, please visit our website and download the “Digi-Wave™ Technology White Paper”.

## DLR 400 ALK Differences

---



The DLR 400 ALK uses 2 AAA alkaline batteries rather than a rechargeable battery like the DLR 400 RCH.

The AAA alkaline batteries can be inserted by removing the panel on the back of the device and putting the batteries in place with the correct polarity. When changing batteries, always change both batteries at the same time.

Help Williams AV protect the environment! Please recycle batteries once they are drained.

### Other Differences

The DLR 400 ALK allows you to select a group via the up and down arrows on the front of the device. The volume may be adjusted using the vol buttons. There is no menu system otherwise.

The battery and signal strength indicators on the screen work similarly to the DLR 400 RCH, but are located on the far left of the screen.

When discussing DLR Receivers, this manual is usually referring to the DLR 400 RCH.

# DLT 400 Controls and Connectors

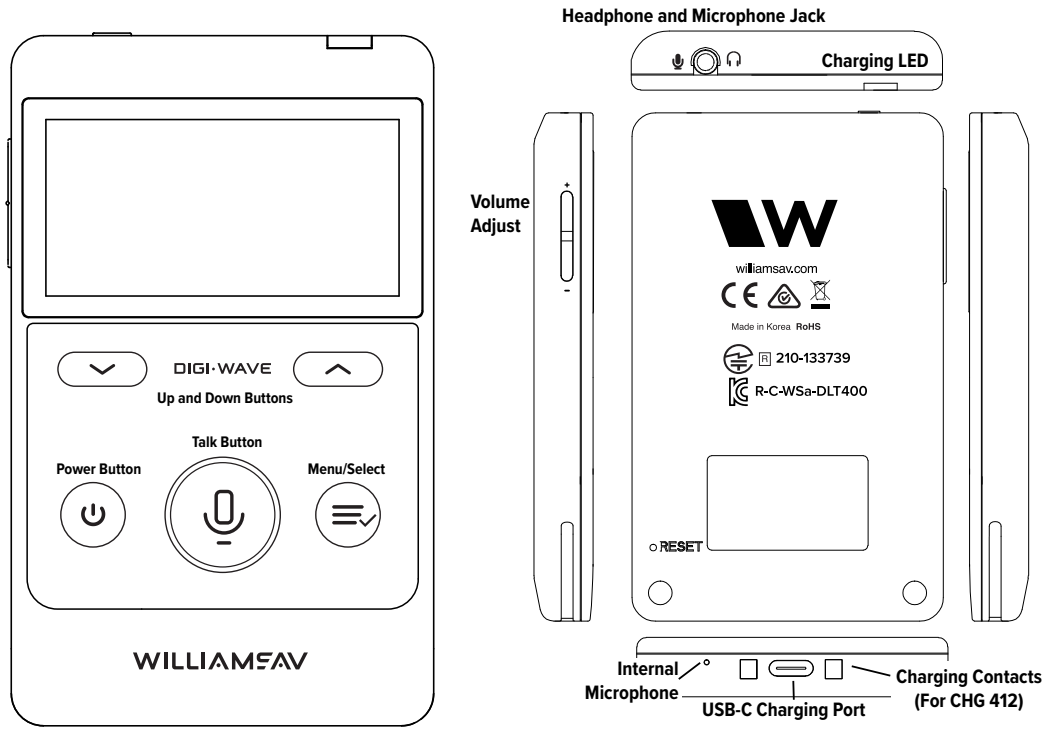

# DLR 400 RCH Controls and Connectors

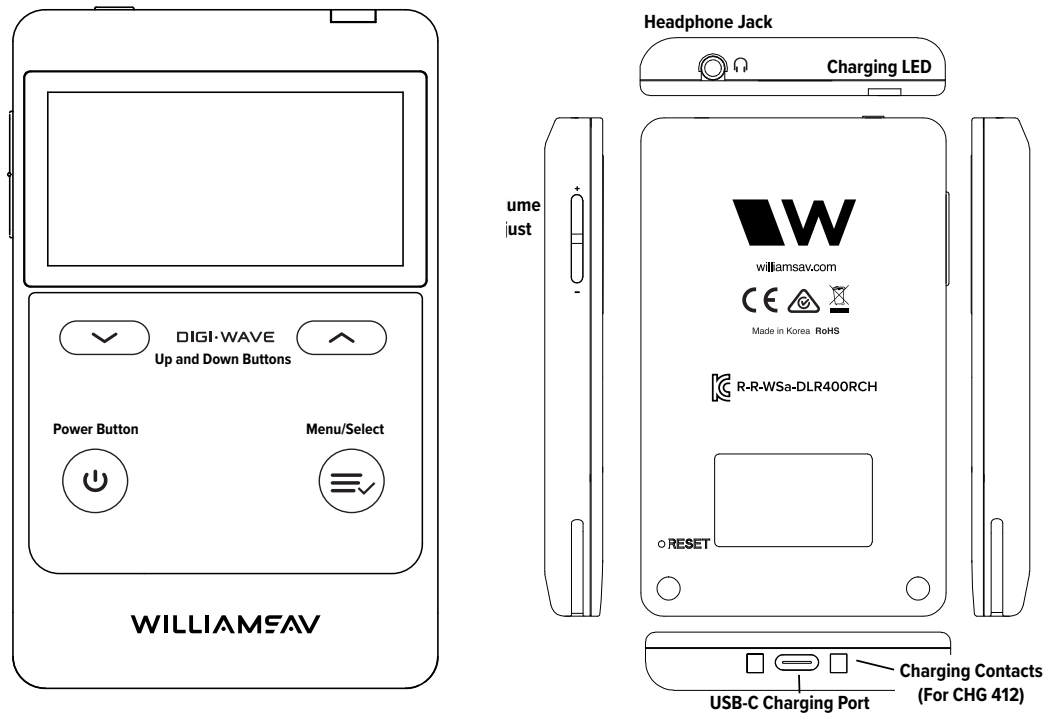

# General Operation

---

## Button Functions

### Power Button

- Press and hold for power On/Off
- Press quickly to navigate back a step when using the menu.

### Volume Control Buttons (on side)

- Adjust the headset's volume.

### Talk Button

- The talk button will need to be used in order to talk or stop talking. There are two modes for the Talk button. For more details, see "Talk Mode: Push-to-Talk and Push-n-Latch (DLT Master 2 and Guest Only)" on page 13.
- This button is only on the DLT transceivers.
- Devices with a Master 1 or Master 2 Speaking Priority can override any speaking Guests by holding down talk button.

### Menu/Select Button

- Press once while on the main screen to view additional Digi-Wave Information, such as firmware version.
- While on the main screen, hold the menu button down for a few seconds to enter the settings menu.
- While in the settings menu, press the menu button to select the highlighted option and move onto the next step.
- While in the settings menu, hold the menu button to exit the menu.

### Up and Down Buttons

- Navigate through menu items.
- Adjust settings
- In Bilingual Mode, toggle which language is spoken.

## Locking the DLT Buttons and Screen

### Basic Lock

Lock enables the Administrator to prevent unauthorized changes to the system set-up by preventing the user from accessing the menu and using the up and down arrow buttons.



### **NOTE: Each DLT has to be locked and unlocked individually.**

- To enable or disable the lock, hold down the volume up button and hold the menu button at the same time for 2 seconds. The lock icon will appear
- When lock is enabled, the menu system will have most features unavailable with a lock icon displayed next to it.

### Locking/unlocking DLR Buttons and Screen

Locking prevents the user from changing Group/Channel. While locked, Volume up/down and Power on/off can still be changed.

### DLR 400 ALK

To lock:

- Hold the ^ and Vol+ buttons down together until the word "GROUP" begins flashing.
- Rapidly press the ^, ^, v, v buttons and "SL" will be displayed.
- The unit is now locked.

To unlock:

- Rapidly press the ^, ^, v, v buttons and then hold down the ^ and vol+ buttons (together) until the word “GROUP” begins flashing.
- Verify the Group Number displayed is the desired group. If not, change it with Vol+/Vol- buttons.
- Hold down the ^ and vol+ buttons (together).
- The unit is now unlocked.

### **DLR 400 RCH**

To lock: Hold the Vol+ (on the side) and Menu/Select buttons down together until lock appears on the screen.

To unlock: Hold the Vol+ (on the side) and Menu/Select buttons down together until unlock appears on the screen.

## **Battery Charging**

Use the USB-C located on the bottom of DLT transceiver or the DLR 400 RCH Receiver, to charge the battery. Charge by either using a USB-C cable or using an approved, compatible Williams AV charging station.

Full charging time is approximately 5 hours. The charging LED flashes red while charging. The charging LED will turn to a steady green light when the battery is charged.

**NOTE: The DLR 400 ALK receiver uses alkaline batteries and is NOT rechargeable. Do not place these models in a charging station.**

### **Additional information**

- The DLT 400 transceiver uses an internal rechargeable Lithium Polymer battery.
- The DLR 400 **RCH** receiver is rechargeable and uses a Lithium Polymer battery. **Do not charge the DLR 400 ALK.**
- Charge the battery at room temperature.

## **⚠ CAUTION!**

All lithium batteries have a limited number of charge/discharge cycles. Lithium batteries may experience swelling if used beyond their expected life cycle (~2 years with casual usage. Heavy usage will reduce the life cycle). If you notice swelling of the battery, please discontinue use and have the battery replaced. We recommend battery replacement after 2 years of use.

## **Before Programming the Digi-Wave™ System**

Depending upon the mode chosen, up to six people can talk in a group at any given time. The Master 1 will have first priority, Master 2 has second priority and Guest units have third priority. When two or more people are talking in a group, the participants can hear their voices with the DLT transceivers or DLR receivers, but only those with a DLT transceiver have a microphone and can speak.

## **Modes**

The Digi-Wave 400 system has been designed for ease and flexibility. Many of the settings are automatically configured for common use cases. These use cases are Tour Mode, Intercom Mode, Hearing Assistance Mode and Interpretation Mode.

While the modes are named by their most common usage, select the mode that fits your personal use case best. The mode is a just starting point; advanced settings can be adjusted to fit your situation.

### Modes

#### **Tour**

Tour mode is best suited when one or two people are leading a large group. The group can be configured to only listen to the leader(s) of the group, such as on a museum tour. Alternatively, this mode allows people with a transceiver to speak, which may be useful for tours through noisy areas where hearing may be difficult, such as factory tours.

#### **Intercom**

Intercom mode is appropriate when a group of up to 6 people all need to talk to and hear one another. It may be used behind the stage to manage a large theater production, or for a security team at a club.

## Hearing Assistance

Hearing Assistance mode is appropriate when using the device to amplify spoken communication between users. The Tone Control in Hearing Assistance mode is automatically elevated, allowing the user to hear more clearly. Users with transceivers can be allowed to speak, which may be useful in a classroom setting.

## Interpretation

Interpretation mode is best suited when dealing with multiple, simultaneous audio feeds. In normal interpretation mode, an interpreter may be translating a speech given in Spanish into English, a group of interpreters may be translating a speech in English into several languages. Up to 14 languages and the floor may be broadcast on the Digi-Wave system at one time.

## Court

Court mode allows toggling between secured groups, without letting the Guest unit on an unused or incorrect Group. A Guest unit can access up to four pre-selected groups, but nothing else. Although this mode is named Court Mode, this mode can be used whenever a limitation to group selection is needed.

## Interpretation Mode: Broadcast Type

When in Interpretation Mode, you will be required to select a broadcast type. The broadcast type helps determine which channel the DLT transceiver will broadcast on.

**Floor** will broadcast on channel 0. This is intended to be the main audio for the event that is being interpreted.

**Interpreter** will broadcast on channel 1 - 14 depending on what is available. Each channel is able to be used by a dedicated interpreter. All interpreter units can hear the Floor on channel 0, and transmit the Interpreter's voice on channels 1 - 14. At any time, by changing channels, anyone can listen to the Floor on Ch. 0 or any Interpreter on channels 1 - 14. The interpretation is broadcast 1-way in up to 14 languages.

**Repeater** is used to extend the range of the Digi-Wave 400 system by up to 50%. The repeater will broadcast on one channel, depending on which channel(s) needs to be extended. This mode does not require a person to be speaking or listening to the transceiver.

For more information on additional features of Interpretation Mode, see "Interpretation Mode Features" on page 15.

## Speaking Priority

There are 3 levels of priority.

- Master 1 has first priority, and also sets up a majority of the settings for the Digi-Wave system. **There can be only one Master 1 unit per group.**
- Master 2 has second priority when speaking, but does not declare any settings for the Digi-Wave system, only for their personal device. **This is not available in Interpretation mode.**
- Guest units have third priority, and can only declare settings for their personal devices.

The Master 1 and Master 2 have the ability to lock out other talkers by holding down the Talk button for three seconds. All system Talk LEDs will continuously flash while other participants are locked out of the Talk feature. The Master 1 can override anyone else talking within the group. Master 2 has talking priority over Guests.

The Master 1 or Master 2 must have their talk button deactivated to allow the Guest units to talk. When 2-6 people are talking in a group, the participants can hear their voices in the DLT transceivers or DLR receivers. DLR receivers can only listen, as they do not have a microphone or talk button.

If a Master 1 unit leaves the conversation, the other devices in the group cannot continue the conversation without them. A Master 1 must be present for the Digi-Wave system to be used.

## Groups and Channels

Depending on the Mode you select, you will primarily be working with Groups or Channels. Both settings determine who hears the audio, and are very similar in concept.

**Groups** are used in every mode. A group is a selection of people communicating with one another. For instance, there may be one tour group for a basic tour and another tour group for a VIP tour. Both these groups may be



in the same area, but their audio will not overlap since they are in different groups.

**Channels** are used in Interpretation mode. Users configure their device to listen to a certain channel based on what they need to hear. For instance, in Interpretation mode, there may be a channel per language. Users will listen to the channel for the language they speak, and not hear the audio for languages they do not understand.

In a theatre with two showrooms, the Digi-Wave system may have a group for each theater. Each group may have up to 15 channels of audio in use. Each user will need to be assigned the correct group for the theater they are sitting in, as well as the correct channel for the appropriate audio.

## Addresses

Addresses are unique numbers given to each Digi-Wave transceiver in a set up. Typically, addresses will be automatically assigned but in some use cases, manual assignment may be necessary. If manually assigning addresses, make sure each address is unique; addresses between 0 and 1023 can be selected. Each of the 1024 addresses is available per group.

DLR receivers do not have addresses.

## Selecting Group(s) and Channel(s)

Each set of people who want to talk and/or listen to each other must be in the same group. Up to 4 Groups can operate simultaneously within range of each other. Up to 15 channels can be used simultaneously.

Group numbers and channels are selected via the settings menu. Pressing the up or down button will allow you to manually select the group or channel number.

## Profiles

Configurations of settings can be saved to a Profile to be easily reloaded later. A profile may be created on any device and loaded later. Profiles are useful when Digi-Wave devices are used in multiple ways, such as being used for both Tours and Hearing Assistance.

## General Rules of Operation

The following rules must be followed. Failure to adhere to these rules will result in unpredictable, unsupported operation.

- There must be only one Master 1 per group.
- Master 2 is optional, and there can only be one per group.
- Any other DLT 400 units must be a Guest unit.
- Each DLT transceiver must have its own address and the address cannot be duplicated within a group.
- Each group must be assigned its own group number. Williams AV recommends a maximum of four groups using the system simultaneously within the same area to prevent interference.
- When using four simultaneous groups, group numbers must be sequential. i.e. 11, 12, 13, 14. Any numbers 0-1023 can be used (only 0-99 if DLR 360 or DLT 400 ALK receivers are being used).

## The Main Screen

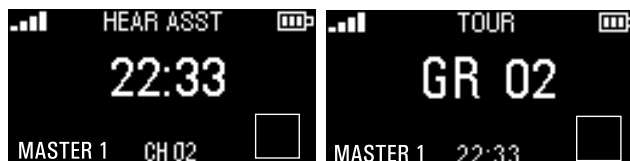

## Display Settings

The mode will be displayed at the top of the screen, between the signal strength indicator and the battery level indicator.

Depending on your setting selections, the clock, the channel or the group will be displayed in the center of the screen. Channel or Group is determined by your mode. A large or small clock is determined by the Master 1 settings.

To change any of these settings, hold down the menu button. For instructions on configuring the Digi-Wave system, see “Basic Settings” on page 11.

## Signal Strength Indicator

When a Master 1 is available on the group or channel, the signal strength indicator on DLR Receivers and Guests will indicate how strong the signal is.

When a Master 1 is not available **OR** while the Master 1 is changing settings that may affect other devices, the icon will disappear. Once the Master 1 has been set up, the DLR Receiver and other DLT transceivers should rejoin the group or channel automatically (with some exceptions, such as a Security PIN being set).

## Attendee Checking

The number of DLT transceivers currently talking will be displayed in the bottom right corner box. It does not count DLR Receivers because they do not have a talk button.

## Priority Indicator

A label indicating Master 1, Master 2 or Guest will appear on the lower left of the screen on the main screen.

If the label is blinking, the device has not had its settings configured. Enter the menu system to begin configuring the device.

# Setting Up the Digi-Wave™ System

---

Settings of the Digi-Wave system should be selected based on how the system will be used. A Master 1 device will declare a majority of the settings and pass these settings to devices that connect with it. Since the Master 1 automatically sets most settings, there is little to be set up on Guest devices for basic usage of the Digi-Wave system.

For more information on terminology and a general system overview, see “Before Programming the Digi-Wave™ System” on page 7.

## Language

The Digi-Wave menu is available in multiple languages. Select the language you desire for set up.

## Initial Setup



When a DLR Receiver or a DLT transceiver is first started, some settings will need to be selected before the device can be used. There are three ways to load settings on a Digi-Wave device:

## New Settings

To start from the very beginning with your Digi-Wave settings, select New Settings. This will start you at the beginning of the set-up process where you can set Basic Settings (see “Basic Settings” on page 11).

## Load Profile

To load an existing profile on the device, select this option and then select the profile to load. You may either load a profile as it is, or adjust the settings once it is loaded (see “Basic Settings” on page 11).

## Join Group

If a Master 1 is already leading a Group or Channel, Digi-Wave 400 transceivers and receivers can automatically search for the group and join it. The list of available groups will be in the order the device detects them, which may not be in numerical order.

The group or channel number could also be manually entered from this screen. Settings will be loaded from

the Master 1 device, once a connection is established.

If a group or channel is locked by a PIN, the device will prompt for the PIN at this time. The device will be unable to join the group or channel without this PIN.

**For interpretation mode, a Master device should not use this feature.** They will be unable to select the channel they desire. Please configure the device using the normal setup menu. Guest units can use the Join Group function normally.

When using this feature to join a group, Addresses will be automatically set. If you need manual addresses, the DLT 400 will need to be set up using a profile or through setting up New Settings.

If the group should not be able to be automatically joined, this feature can be disabled by the Master 1 device for specific groups. See “Allow Join Group” on page 15 for more information.

## Changing Settings

If settings need to be adjusted later, the menu system can be reentered at any time by holding down the menu button for a few seconds. From there, settings can be edited by selecting **New Settings**. You may also load a profile or join a group or channel.

The menu system can be exited at any time by holding the menu button. Any uncustomized settings will be set to their default.

To go back to a previous setting while in setup mode, press the **Power** button.

## Basic Settings

Always start setting the Digi-Wave settings with the DLT transceiver that will be the Master 1. Other devices can gather their settings from the Master 1 device to ease setup. DLR Receivers and other DLT transceivers that are not Master 1 may still need their settings adjusted, but they should still be set up after the Master 1.

1. Select a Mode. This determines what other settings may be available. See “Modes” on page 7 for more details on the various modes.
2. Select Speaking Priority. If this is the first DLT transceiver you are setting up, you will want to select Master 1. Typically, all other units will be Guest priority. See “Speaking Priority” on page 8 for more details on the various speaking priorities.
3. Select the group number. Holding down the up or down button will seek for available groups/channels. Pressing the up or down button will allow you to manually select the group or channel number. For more information on groups, see “Groups and Channels” on page 8.
4. If in Interpretation Mode, set the Broadcast Type (see “” on page 11).
5. The Master 1 can select a handful of options that will affect the main display on other devices:
  - Select whether to display clock or hide it entirely.
  - Select the clocks location, if displayed.
  - Select whether the clock is a 24-hour or 12-hour clock.
  - Set Master 1 manual address. (Guests and other device can set the address under Advanced Settings.)  
**Automatic address selection is recommended unless there is a need to override the address.**
6. Enter Advanced Settings (See “” on page 11) if more customization is needed, otherwise the device is ready to be used.

# Advanced Settings

Advanced Settings are usually available regardless of the mode selected, but some Advanced Settings may be missing from certain modes, or with certain configurations.

## Number of Microphones (DLT 400 only)

In modes where multiple speakers are available, the number of speakers at one time can be limited. The maximum number of speakers is 6, the minimum is 2 when this option is available. The number of microphones is not limited by the selected mode (except for in Interpretation Mode, which assumes one speaker per channel). Users with DLR Receivers do not have microphones or talk buttons and cannot be speakers in any circumstance.

Only 4 speakers using DLT 300 transceivers are allowed. 6 speakers can still be in the group, but the 5th and 6th speakers must be using DLT 400 transceivers.

## Advanced Comms Mode only Setting (DLT 400-ACM only)

Power on/off with DWD. Turn on/off w/WD” is default. This setting means that if a DLT 400 is connected to a Digi-Wave Connect (DWD 401), when the Digi-Wave Connect turns on/off, the DLT will turn on/off with it. “Turn on/off manual” means that the DLT connected to a Digi-Wave Connect (DWD 401) can be turned on/off independently of the Digi-Wave Connect. If the Digi-Wave Connect loses power, the DLT 400 will stay turned on, powered by the battery.

### Example - Tour System

The system has been configured so that up to four people can have open microphones and be talking at the same time. One DLT is set up as a Master 1 unit for the tour guide. Each tour member has a DLT transceiver set up as a Guest unit.

When a 5th person desires to speak, they push their talk button. This deactivates the talk button of the first Guest that turned their microphone on. This First-In-First-Out speaking priority continues each time a member pushes their talk button who is not a part of the speaking group.

If the group speaking needs the 5th person to be able to speak, they can adjust their device settings to allow 5 speakers.

The Master 1 or Master 2 Tour Guide has the ability to take control of the discussion by overriding Guest units, if needed. This is accomplished by pushing-and-holding their talk button down for a few seconds which mutes all Guest unit microphones. When overriding, the talk button will blink red.

A second Tour Guide may be added as a Master 2 unit, which takes priority over Guest units. Master 1 and 2 units have two-way communication capability; they can talk/listen simultaneously to one another.

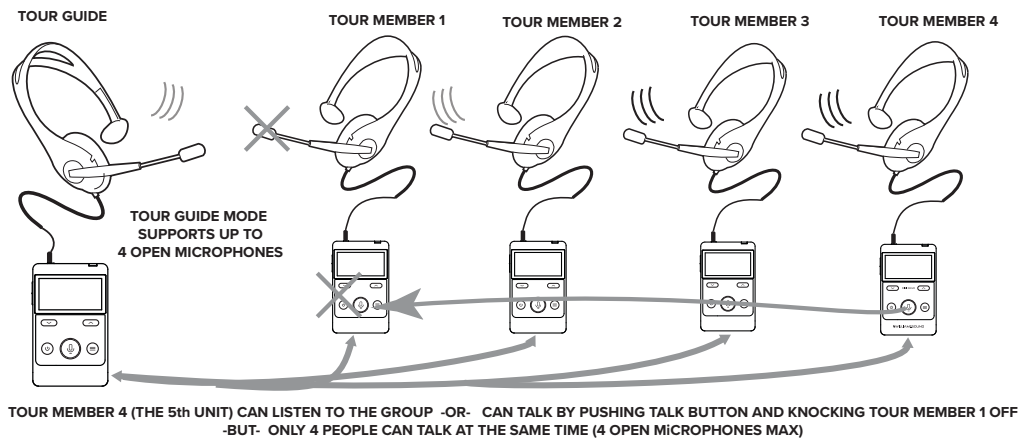

### Example - Intercom

One DLT transceiver is set up as a Master 1 unit. All other DLT transceivers are programmed as a Guest unit. Up to six people can have open microphones and be talking at the same time. When a 7th person desires to speak, they push their talk button. This deactivates the talk button of the first Guest that turned their mic on. This First-

In-First-Out order continues each time a member pushes their Talk button who is not a part of the speaking group.

## Talk Mode: Push-to-Talk and Push-n-Latch (DLT Master 2 and Guest Only)

On a DLT transceiver, the **Master 2 or Guest** Talk Mode can be changed to Push and Latch or Push to Talk. Master 1 DLT transceivers are always set to Push-N-Latch mode. This feature is not available on a DLR Receiver as it does not have a microphone or talk button.

In **Push-n-Latch** mode, when the talk button is pressed and released, it stays in talk mode until the talk button is pressed and released again.

In **Push-to-Talk** mode (the default mode), the talk button must be held down while speaking, and when released, it shuts off.

In **Talk blink in ALL-CALL**. (Advanced Comm Mode only) This will allow the light to flash when ALL-CALL is activated, this is an option for where a blinking light may be disturbing. If you select yes, the light will not flash during ALL-CALL.

## Tone Control

The default for tone control is 5, unless in Hearing Assistance mode, where the default is 9.

Using the up and down arrow buttons, adjust the tone up or down to your preference. The number range indicates:

- 1 = Most bass response
- 5 = Flat
- 9 = Most treble response

## Side Tone Adjustment

This gives the user the ability to change the volume of their own voice as heard in the headset (side tone). This feature is only available on the DLT transceiver.

Use the up and down arrow buttons to choose between off (0 dB), low (-12 dB), or high (-6 dB).

## Microphone Gain, Line Input Gain and Line Output Gain

Gain can be used to increase the volume of the microphone or line input sound. Line input is connected via a USB-C connector.

Use the up and down arrows to adjust the gain to a suitable level. The default value for the microphone gain is 33. The default value for the line input gain is 5. The default value for line output gain is 0, but can be adjusted to +4dB.

**Note: For setting up an input line interface, please contact TechBlue Technical Support.**

## Power w/DWD

“Turn on/off w/ DWD” is default. This setting means that if a DLT 400 is connected to a Digi-Wave Connect (DWD 401), when the Digi-Wave Connect turns on/off, the DLT will turn on/off with it. “Turn on/off manual” means that the DLT connected to a Digi-Wave Connect (DWD 401) can be turned on/off independently of the Digi-Wave Connect. If the Digi-Wave Connect loses power, the DLT 400 will stay turned on, powered by the battery.

## Auto Off

Auto Off w/o sync” is default. This setting means the the DLT 400 or DLR 400 RCH will turn off after 5 minutes of not being connected to a MASTER or MAIN SYNC unit in order to save battery life. “Always on” means that the DLT 400 or DLR 400 RCH will stay on even if there is no MASTER or MAIN SYNC unit present.

## Sleep Mode

“No sleep mode” is default. This setting means that the DLT 400 or DLR 400 RCH display will always stay on. There are three options for sleep – after 30 seconds, 1 minute or 5 minutes. If one of those options are chosen, then the display or the DLT 400 or DLR 400 RCH unit will turn blank after the prescribed time. The display will be activated again by any button press.

## Display Clock

The clock can be displayed in several formats on the main screen. It can be shut Off, displayed Big in the center of the screen, or displayed Small near the bottom of the screen (default behavior).

The group or channel will be displayed at the bottom of the screen in small font if the clock is set to display big. The group or channel will be displayed in the center of the screen if the clock is set to off or small.

## Manual Group and Address

If the Group or Address needs to be adjusted, it can be set here. This may be necessary if needed to be backwards compatible with the DLT 300 or DLR 360 from the previous generation.

## Encryption

Extra security can be added to the transmitted signal via encryption. The “**300 Compatible**” 87-bit encryption is default. This level of encryption is backwards compatible with the DLT 300 from the previous generation. The DLR 360 cannot work with encrypted signals.

**128 + 87-bit** Encryption adds AES-128 encryption on top of the 87-bit encryption. This adds an additional layer of security, but is not backwards compatible and may only be used with Digi-Wave 400 devices. This method requires an Encryption PIN.

## Encryption PIN:

When a group or channel has been set up with a Encryption PIN, master and guest transceivers and DLR 400 receivers without this Encryption PIN entered cannot listen in on the group. This may be desirable in private or high security-level functions. **The PIN cannot be used with DLR 400 ALK units.**

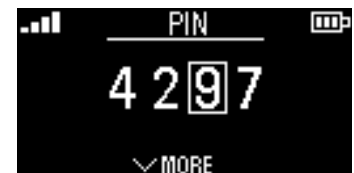

The same four digit code must be programmed into all of the Digi-Wave devices in the group. If a different secure code has been entered, participants cannot re-enter the group without re-entering the correct secure code. The only time the Encryption PIN is displayed is when it is being entered. As the PIN is being entered, individual numbers will be replaced by the \* symbol.

**We recommend using a unique PIN to your group. Using PIN 0000 or other easily entered or guessed PIN will not be as effective as a unique pin.**

To set the PIN:

1. Select whether or not the connection requires a PIN. If yes, you will be prompted to enter the desired PIN.
2. Choose a 4 digit numerical code; i.e. 4297. You must use the same code on each device in the group.
3. Using the up and down arrows, enter first digit of the code (0 – 9).
4. Press the menu/select button to move to the second digit. Enter the next digit and continue until all four digits have been entered.

When setting up the other transceivers or receivers for this group or channel, enter the same code into those devices.

When the Encryption PIN is set, a key icon will show on the main screen under the signal strength indicator.



To remove an Encryption PIN when using 300 Compatible mode (Pins are required in 128+87 mode):

1. Go through the menu system until you are prompted if you would like to use a PIN code.
2. Select "NO PIN CODE." The existing PIN will be removed.

## Allow Join Group

The Master 1 can prevent other devices from seeing the group as available to join. Disabling Join Group will prevent available groups from being listed under the Join Group menu. Devices will have to be manually set to the correct group or channel.

See "Join Group" on page 10 for more details on the Join Group feature.

## Factory Reset

If the Digi-Wave device is not behaving correctly, or otherwise needs to be reset, a factory reset option is available. This is the last item in the Advanced Settings menu. If the device is reset, all changes selected before this reset will be lost. The factory reset can also be done manually. A hole is on the back of the device. The hole covers a switch that can only be reached with a paper clip or other thin material. Pressing the button with the paper clip while the device is on will display a prompt on the screen asking to perform a factory reset. Select Yes to reset the device.

## Interpretation Mode Features

Interpretation Mode has several features not available in other Digi-Wave modes. During setup, you will be prompted to select a broadcast mode and select an additional interpretation mode. The available options for broadcast mode are Floor, Interpreter and Repeater. The available options are for the additional interpretation mode are Standard, Bilingual and Relay.

### Floor and Interpreter

The floor is the main speaker or audio of the event. In a lecture, this is the person standing at the podium. Interpreters translate the audio from the floor into another language. There can only be one floor in a Digi-Wave system, but there can be up to 14 interpreters.

The floor will always broadcast their audio on channel 0. Interpreters

can broadcast their audio on channels 1-14. Interpreters can listen to channel 0 as they interpret in standard interpretation mode.

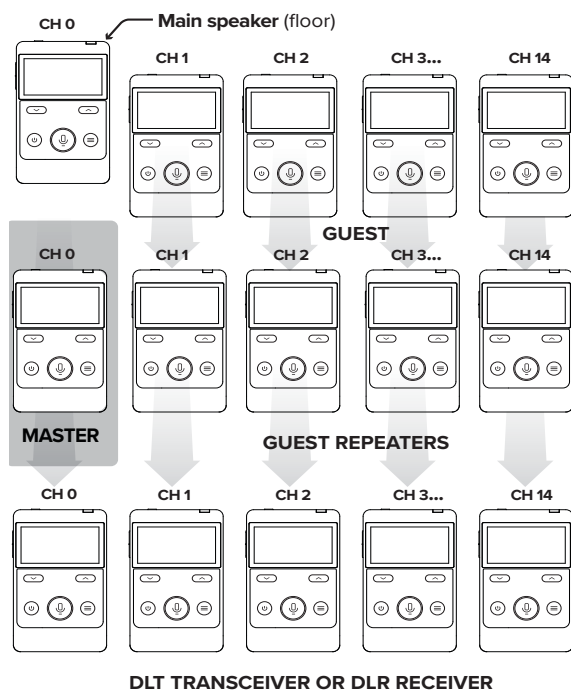

## Repeater Broadcast Mode

Repeater mode can be entered by selecting it as the Broadcast Type during setup.

An additional DLT 400 can be set-up as a repeater to increase the range of each channel.

When repeater mode is used, the Repeater is configured as the Master 1, and all units sync to this Master Repeater. The floor unit should be configured as a guest.

There can only be one repeater per channel and one of the repeaters must be a Master unit. In basic scenarios, it is best to set the Repeater on Channel 1 since most connecting devices can easily access this channel.

## Standard Interpretation Mode

Standard interpretation mode allows for each DLT transceiver to listen to the floor (the main speaker) on channel 0 and broadcast out in one interpreted language on a channel (1-14). Each additional channel or language requires their own DLT transceiver and interpreter. The audience member then listens to the channel for their specific language.

**Note: In previous Digi-Wave versions, this was known as Simultaneous Interpretation Mode.**

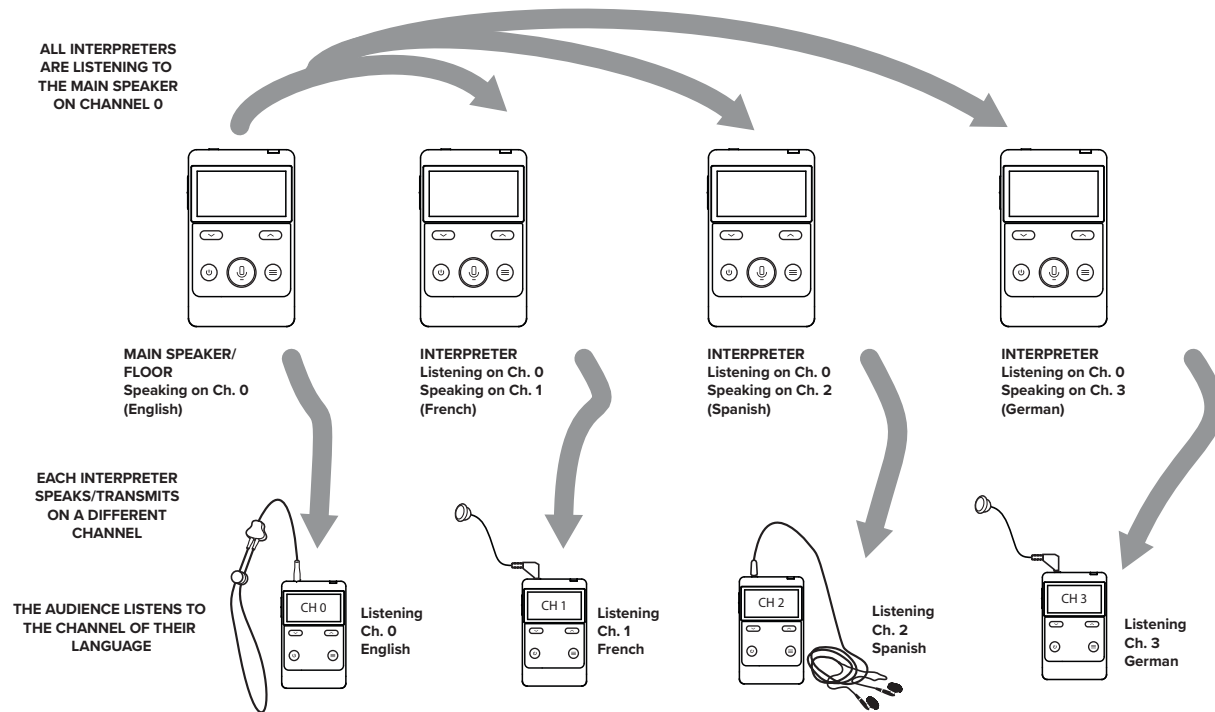

## Bilingual Mode



Bilingual mode allows the interpreter to quickly switch their output channel between Ch. 1 or Ch. 2, depending on which language the audience needs to hear.



This mode eliminates the need for the interpreter to physically switch between 2 DLT transceivers programmed to fixed channels. The interpreter can easily switch between which channel is being broadcast by using the up or down arrow under each channel listed.

For example, the Floor changes from a Japanese speaker to an English speaker. When the Floor is speaking Japanese, the bilingual interpreter selects Ch. 1 as the output channel and interprets Japanese to English to the English audience. When the Floor changes to an English speaker, the interpreter selects Ch. 2 as the output channel and interprets English to Japanese to the Japanese audience.

The DLT transceiver in Bilingual Mode always listens to channel 0, regardless if channel 1 or 2 is chosen as the transmission channel. Only one DLT transceiver can be programmed to transmit on channels 1 and 2.

The bilingual interpretation mode may be utilized within a larger system. For example, one interpreter can use the bilingual mode on channel 1 and 2, while others have the normal mode on other channels. It does not work with Relay Mode.

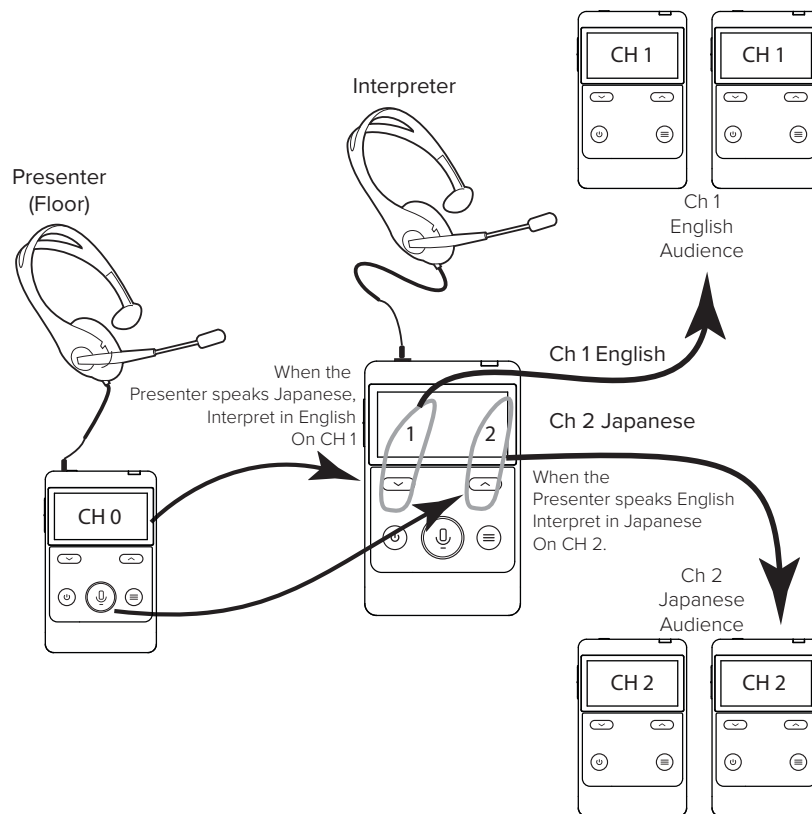

## Relay Mode

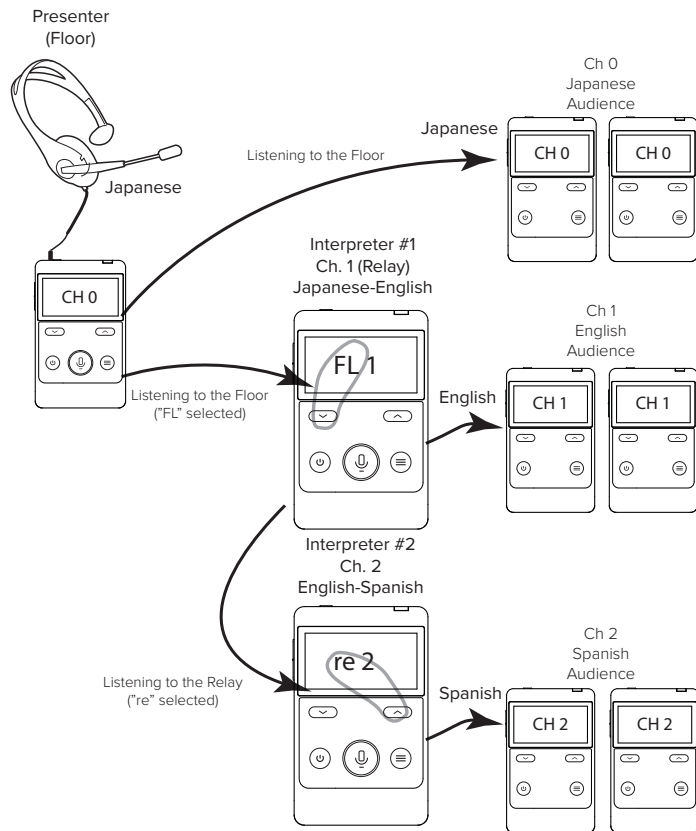

Relay Mode allows the interpreter to quickly switch between listening to the Floor on Channel 0 or the Relay on Channel 1.

For example, the floor is speaking Japanese. The Japanese audience can listen to the Floor on Ch. 0. Interpreter 1 pushes the down button to hear the floor, and interprets Japanese to English to the audience listening on Ch. 1. Interpreter 2 speaks English and Spanish, and cannot translate from the floor as they do not speak Japanese; they need to listen to Interpreter 1's translation as a relay. Interpreter 2 listens to the relay (Interpreter 1) by pushing the up button and interprets English to Spanish to the audience listening on Ch. 2.

Channel 1 is automatically the Relay channel. Channel 1 will automatically listen to Channel 0, just as in Standard Interpretation Mode. The DLT transceiver transmitting on Channel 1 cannot switch and listening to Channel 1, and the floor cannot listen to channel 1. Interpreters on other channels (2-14) are able to switch which channel they are listening to.

Only one DLT can be programmed to transmit on each channel. All interpreter units must be programmed in the Interpretation with Relay Mode, and cannot be combined with units programmed in other modes.

**Note: Bilingual Interpretation is unavailable in Relay Mode.**

## Court Mode

*Court mode may require a firmware update to version 1.2.0 or higher to be available on your Digi-Wave devices.*

Court mode is used to limit users to specific groups. When not in court mode, a guest Digi-Wave unit can change their group to any group. In Court Mode, the guest unit can only access up to four pre-selected groups.

Limiting the access to groups may be useful in situations requiring privacy and security, such as in a court. For example, a lawyer may need to privately consult with their client on Group 12, and may also need to listen to the judge on Group 10. To prevent the lawyer from accidentally broadcasting private case information on any other Group, the lawyer would be limited to only accessing Groups 10 and 12.

PIN codes can be assigned to a Group to further secure access to a group. Court mode has the added benefit of quickly toggling between groups, even if they require a PIN code, without letting the Guest unit end up on an unused or incorrect Group.

Although this mode is named Court Mode, this mode can be used whenever a limitation to group selection is needed.

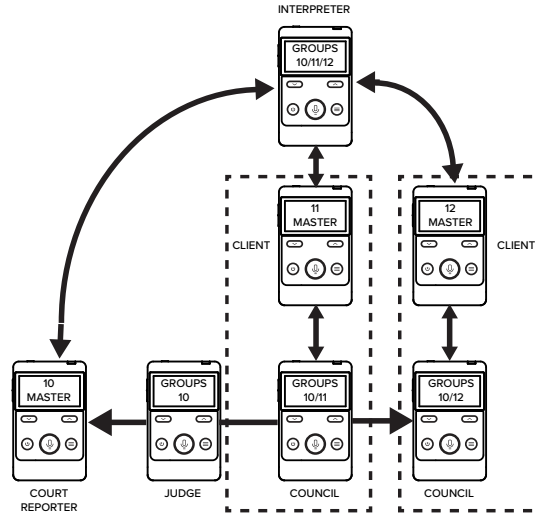

### Device Availability

Court Mode is only available for DLT 400 transceivers and DLR 400 RCH receivers. It is not available for DLR 400 ALK units or for backwards compatibility with the Digi-Wave 300 Series.

For older Digi-Wave 400 series units, a firmware update may be required to use Court Mode.

### Group Selection

A Master unit can only be in one group and cannot toggle between groups. Like most other modes, the Master unit will be programmed with the settings for one specific group.

Guest units can access up to four groups. The Guest will be able to add up to four groups. If a PIN code has been set up for the group, the Guest will be required to enter it when they add the group. PIN codes are only available in with Encrypted signal transmission.

Both the Master and any Guest devices must be set to either encrypted or unencrypted signal transmission.

Once the setting for Court Mode have been saved on a Guest device, any Group previously accessible by the unit will be erased from the device. All groups the Guest unit should be allowed access to will need to be entered at once. A single group cannot be added or removed later.

### Toggling Between Groups

Once setup is complete, the Guest unit can use the Up and Down buttons to toggle between the list of groups on the left hand side of the screen.

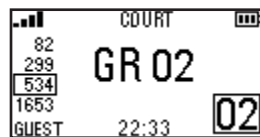

The Guest indicator will flash until the group is joined. If a device seems unable to join a group, check the PIN code.

### Locking the Device

To prevent Guest units from accessing the setup menu, using Basic Lock is recommended. Basic lock can be activated by holding the volume up button and menu button at the same time for a few seconds.

Guest units can still edit some personal auto settings by repeatedly pressing (not holding) the menu button. These settings include viewing the System Information, and Adjusting Mic Gain, Side tone, and Tone. Volume is adjustable using the volume up and volume down buttons.

### Microphone Mute

Court mode requires Push-n-Latch mode. Push-to-Talk mode is not available in Court mode. To mute your microphone, press the Talk button so the red light around the Talk button is no longer on.

Holding down the talk button will not mute all speakers in court mode.

## Saving and Replacing Profiles

After settings have been configured, you will have the option to save your settings as a profile, or replace an existing profile. This is only available if Advanced Settings have been adjusted.

If you choose to not save your profile, the device will still use the settings but they cannot be loaded again if the settings are later changed.

### Saving Profiles

After selecting your settings, you can select a numbered profile where you can save your settings. Five profiles are available.

Profiles that are being used have a disc icon next to them. Profiles can be overwritten if desired.

Select the profile name to use to save the settings to the profile. If the profile is already in use, confirm that you are replacing an existing profile.

### Loading Profiles

For information on loading profiles, see “Load Profile” on page 10.

## Differences between DLT 400, DLT 400-AIM, DLT 400-ACM

Function/Description	DLT 400	DLT 400-AIM	DLT 400-ACM
Crystal-clear digital sound	x	x	x
One-way and two-way capability	x	x	x
Full duplex communication	x	x	x
Six simultaneous talkers	x	x	x
Unlimited receivers	x	x	x
Portable - no base station required	x	x	x
Compatible with Digi-Wave Connect	x	x	x
128 + 87-bit encryption	x	x	x
Pin protection	x	x	x
One transceiver true interpretation	x	x	x
14 interpretation channels + floor	x	x	x
Custom naming		x	x
Subgroup division		x	x
Offline programming control function		x	x
Interpretation Q&A capability		x	
24 channels		x	
All-Call function			x
Flex-sync capability			x
Seamless quick sub-group switching			x

## Updating DLT 400 and DLR 400 RCH Firmware

The Digi-Wave® system should ship with the latest firmware; however, over time systems may need to be updated. A Digi-Wave® Downloader program will need to be installed onto a computer in order to load the firmware onto the Digi-Wave® device. The Downloader is a separate software download from the Digi-Wave® firmware itself. Please contact Tech Blue at [techblue@williamsav.com](mailto:techblue@williamsav.com) to receive the Downloader program and user instructions.

## Advanced Interpretation Module

The Advanced Interpretation Module (AIM) introduces the following new features to a Digi-Wave® system:

- Q&A Mode
- 24-Channel Interpretation Mode
- Control Function
- Channel Naming
- Channel Sub-Groups

Advanced Interpretation Module (AIM) Features are only available for the DLT 400-AIM variant of the DLT 400 transceiver. To check if your DLT is the AIM variant, check if the word “AIM” is present under the battery symbol on the display. Contact your local Williams AV representative regarding possible upgrade paths to the DLT 400-AIM variant.



### Compatibility

- DLR 400 RCH units on firmware version 1.3.0 or higher are compatible. Contact your Williams AV representative to upgrade your firmware.
- DLR 400 ALK units are not compatible with the special AIM features.

## Interpretation Q&A Mode

Interpretation Q&A Mode is used to facilitate Questions and Answers between the audience and a presenter in a bilingual setting. Q&A Mode can also be utilized in bilingual meetings and two-way tours since two open mics for each language are available. This enables a fluent and natural interchange of opinions and commentary across language barriers. Interpretation Q&A Mode is limited to two active languages.

### Devices Required for Q&A Mode:

1. 1 x DLT 400-AIM for Interpreter: Broadcast Type: Interpreter – Master 1- Channels 01 & 02 automatically monitored, can switch output between Channels 01 & 02
2. 1 or more x DLT 400-AIM for presenter/ Delegation 1/ tour guide: Broadcast Type: Participant - Guest or Master 2 – Channel 01
3. 1 or more x DLT 400-AIM for audience question/ Delegation 2/ tour participants: Broadcast Type: Participant - Guest or Master 2 – Channel 02
4. 1 or more x DLR 400 RCH Listen Only, for audience members/ Delegates/ tour participants: Channel 02

## Scenarios for Q&A Mode

### 1. Scenario 1: Presentation with Interpreted Audience Questions

The interpreter listens to CH01 and CH02 consecutively and can speak to the presenter on CH01 and interpret what they hear to the audience on CH02 or the interpreter is listening to the audience on CH02 and interpreting what they hear to the presenter on CH01:

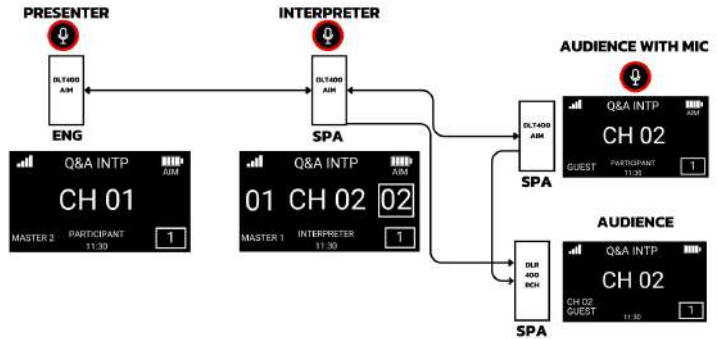

### 2. Scenario 2: Bilingual Meetings with Multiple Participants

Two speakers from both sides (CH01 and CH02) can simultaneously speak and the interpreter is interpreting to CH01 on CH02. (Note a maximum of two people per channel can speak at once and the Interpreter can always speak).

### 3. Scenario 3: Bilingual Two-Way Tours

The interpreter listens to CH01 and CH02 simultaneously and can speak to the presenter on CH01 and interpret what they hear to the audience on CH02. When the interpreter is listening to the audience on CH02 then they can interpret what they hear to the presenter on CH01.

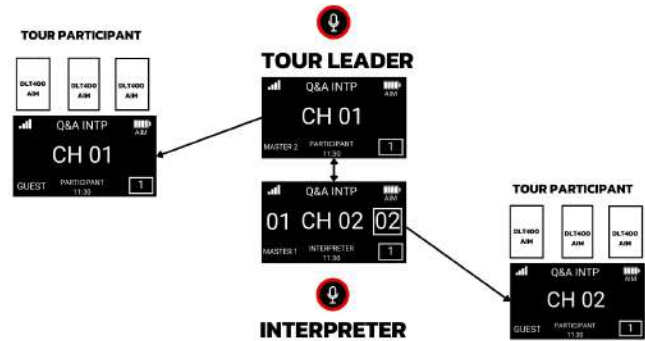

## Programming Scenarios

### Scenario 1: Presentation with Interpreted Audience Questions

#### Devices Required

- 1 x DLT 400-AIM for Interpreter: Broadcast Type: Interpreter – Master 1- Channels 01 & 02 automatically monitored, can switch output between Channels 01 & 02
- 1 or more x DLT 400-AIM for presenter(s): Broadcast Type: Participant - Guest or Master 2 – Channel 01
- 1 or more x DLT 400-AIM for audience questions: Broadcast Type: Participant - Guest or Master 2 – Channel 02
- 1 or more x DLR 400 RCH for audience members (listen only): Channel 02

#### Q&A Interpretation mode supports two languages.

- CH01 is the language of the presenter.
- CH02 is the interpreted language.

BOTH channels are available to the audience.

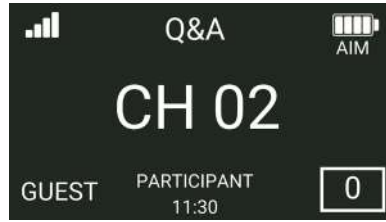
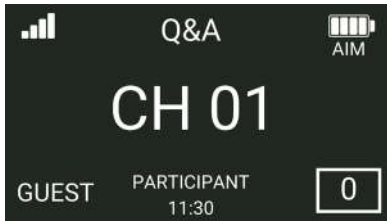

### Simultaneous listening

The interpreter will listen to the audio feed from both CH01 and CH02 simultaneously. The interpreter will toggle their output between CH01 and CH02 depending on which language they are currently interpreting in.

### Switching channels

To switch channels, the Interpreter hits the up or down arrow; A square will surround the channel number that the device is speaking to.

*Example of an interpreter switching from output CH 02 to channel 01:*

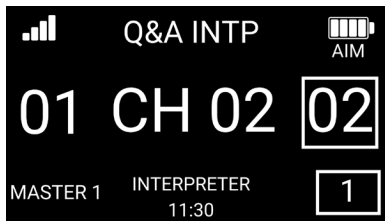

### Interpreting Questions

When interpreting from the main presenter (CH01) into the target language (CH02), output CH02 will be active on the interpreter DLT.

When interpreting a question from the audience (CH02) back to the presenter (CH01), output CH01 will be active on the interpreter DLT.

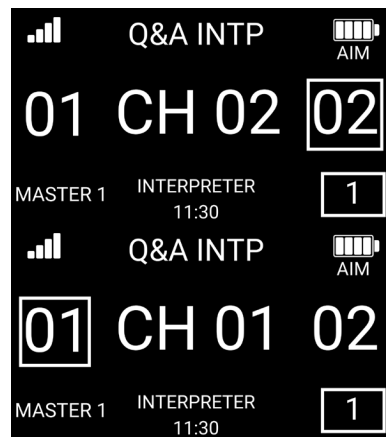

### A. Interpreter DLT

1. Enter programming mode by holding the menu/select button for three seconds, choose your programming language, then select new settings. (Reminder the power button can be used as a back function for mistakes.)
2. MODE: Q&A INTP

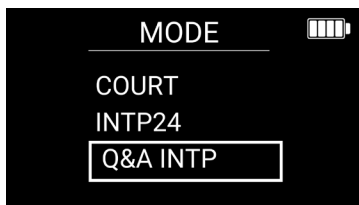

AIM

3. MASTER/GUEST: Master 1. This selection is usually recommended for the interpreter. Every Q&A system requires exactly one Master 1. Master 2 is optional.

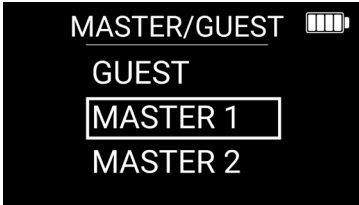

4. GROUP #: Choose a group number. All DLTs and DLRs in the Q&A system need to be connected to the same group.



5. BROADCAST TYPE: INTERPRETER

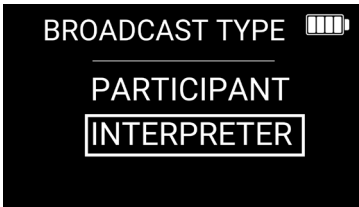

6. CLOCK MODE: As desired (12 HOUR or 24 HOUR)

7. CLOCK: Set current time if desired. All units in the Q&A system will synchronize their time to the MASTER 1 unit.

8. ADVANCED SETTINGS: In most cases, there is no need to go into advanced settings. If you choose NO, then the programming is done. For more information on Advanced Settings, reference page 12 of the user manual.

9. Press TALK to turn on the TALK button for the Interpreter unit.

**\*Note: it is possible to program multiple interpreter units for a setting where several interpreters take turns interpreting. However, only one interpreter can have their TALK button pressed at the same time. An interpreter unit programmed as a MASTER 1 unit can take over the open mic from an interpreter unit programmed as GUEST. An interpreter unit programmed as a GUEST can't take over the open mic from an interpreter unit programmed as MASTER 1 until the MASTER 1 unit presses the TALK button to make it inactive.**

## B. Presenter DLT

1. Enter programming mode by holding the menu/select button for three seconds, choose your programming language, then select new settings. (Reminder the power button can be used as a back function for mistakes.)

2. MODE: Q&A INTP





## 3. MASTER/GUEST: MASTER 2.



This selection is usually recommended for the presenter. Master 2 is optional, but it enables the presenter to always have their TALK button on without risking being bumped off if there are too many open mics in the system.

## 4. GROUP #: Choose the same group number as the interpreter.



5. BROADCAST TYPE: PARTICIPANT. Both presenter DLTs and DLTs for audience questions are programmed as PARTICIPANT.



## 6. CHANNEL: 01. Choose Channel 01 for the presenter language.



## 7. CLOCK MODE: As desired (12 HOUR or 24 HOUR)

8. ADVANCED SETTINGS: In most cases, there is no need to go into advanced settings. If you choose NO, then the programming is done. For more information on Advanced Settings, reference page 12 of the User Manual for more information.

## 9. Press TALK to turn on the TALK button.

### C. Audience Question DLT

The following steps are for a DLT to be used as a microphone for audience questions. We recommend using the plug mount microphone MIC 414 with the DLT 400-AIM unit. Several DLTs may be designated for audience questions, but only two microphones can be active on CH 02 for audience questions at the same time. (1024 DLTs total can be part of a Q&A system.) (Reminder the power button can be used as a back function for mistakes.)

1. Enter programming mode by holding the menu/select button for three seconds, choose your programming language, then select new settings.
2. MASTER/GUEST: GUEST.



- This selection is usually recommended for audience Q&A DLT. Depending on the event, you may choose to designate a DLT for audience questions as MASTER 2. If the audience question DLT is programmed as Master 2, it enables this DLT to always have their TALK button on when desired without risking being bumped off if there are too many open mics in the system. An unlimited number of Master 2 units are possible in a Q&A System.

3. GROUP #: Choose the same group number as the interpreter.



4. BROADCAST TYPE: PARTICIPANT. Both presenter DLTs and DLTs for audience questions are programmed as PARTICIPANT.



5. CHANNEL: 02. Choose Channel 02 for the audience question language.



6. CLOCK MODE: As desired (12 HOUR or 24 HOUR)
7. ADVANCED SETTINGS: In most cases, there is no need to go into advanced settings. If you choose NO, then the programming is done. For more information on Advanced Settings, reference page 12 of the User Manual for more information.
8. Press TALK to turn on the TALK button.

## D. Audience DLR

The following steps are for DLRs to be used as listen only units for the audience to listen to an interpreted language.

1. Enter programming mode by holding the menu/select button for three seconds and choose your

programming language. (Reminder the power button can be used as a back function for mistakes.)

2. SET UP: JOIN GROUP



3. Mode: Select Q&A INTP

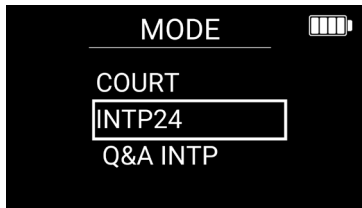

4. SELECT GROUP: Choose the same group number as the interpreter.

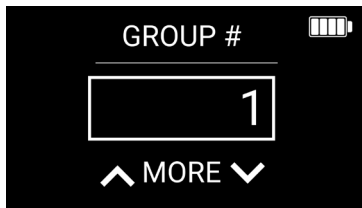

5. The DLR will be on channel 01.

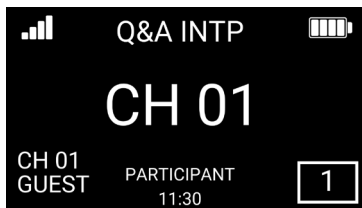

6. Use the arrow up button to go to CH 02 for the interpreted language. Some DLRs may be programmed to listen to the presenter language on CH01 for assistive listening or other purposes.

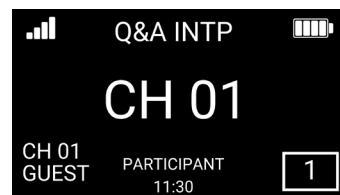
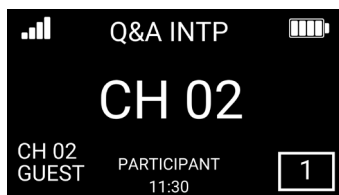

**What to do if the presenter language switches:**

There is no need to reprogram the interpreter DLT or audience DLRs if the presenter languages switches. If channel 01 originally represents English and channel 02 represents Spanish for example, these channel numbers will continue to represent the same languages after a presenter language switch. There are several ways to handle presenter and audience question DLTs.

- You may switch the DLT for the presenter with the DLT for audience questions.

- You may assign a presenter DLT to channel 01 and another presenter DLT to channel 02 and give presenters in different languages different DLT units. The DLTs may easily be identified by different color silicon skins (optional accessory CCS 061 BK, GR, RD or BL). In a similar manner, you may have two different DLTs for questions from the audience. One can be programmed to channel 02 and be used when questions are in one language and one can be programmed to channel 01 and be used when the questions are asked in a different language.
- You may reprogram the presenter DLT from Channel 01 to Channel 02 – and the audience question DLT from Channel 02 to Channel 01

## Scenario 2: Bilingual Meeting with Multiple Participants

Q&A Mode may be used in bilingual settings where multiple participants need to be able to ask questions or participate in a discussion. This mode is useful for meetings where several delegation members in two different languages should be able to have their opinions interpreted into the other language.

Q&A Interpretation mode supports two languages. CH01 is the language of one delegation. CH02 is the language of the other delegation. Two microphones can be active for each language at any one time, enabling two delegates to speak seamlessly at the same time while the interpreter interprets into the other language.

The interpreter will listen to the audio feed from both CH01 and CH02 simultaneously. The interpreter will toggle their output between CH01 and CH02 depending on which language they are currently interpreting into. When interpreting from delegation 1 (CH01) language into delegation 2 (CH02) languages, output CH02 will be active on the interpreter DLT. When interpreting from the delegation 2 (CH02) languages into the delegation 1 (CH01) language, output CH01 will be active on the interpreter DLT.

### Devices Required

1. 1 x DLT 400-AIM for Interpreter: Broadcast Type: Interpreter – Master 1- Channels 01 & 02 automatically monitored, can switch output between Channels 01 & 02
2. 1 or more x DLT 400-AIM for language 1: Broadcast Type: Participant - Guest or Master 2 – Channel 01
3. 1 or more x DLT 400-AIM for language 2: Broadcast Type: Participant - Guest or Master 2 – Channel 02
4. Optional: 1 or more x DLR 400 RCH for listen only participants: Channel 01 or 02

### A. Interpreter DLT:

1. Enter programming mode by holding the menu/select button for three seconds, choose your programming language, then select new settings. (Reminder the power button can be used as a back function for mistakes.)
2. MODE: Q&A INTP

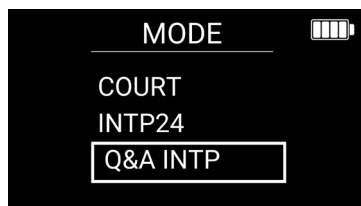

3. MASTER/GUEST: Master 1. This selection is usually recommended for the interpreter. Every Q&A system requires exactly one Master 1. Master 2 is optional.

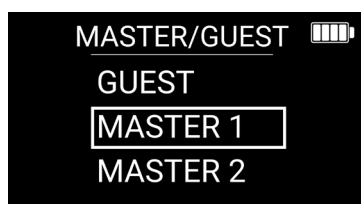

4. GROUP #: Choose a group number. All DLTs and DLRs in the Q&A system need to be connected to the same group.
5. BROADCAST TYPE: INTERPRETER

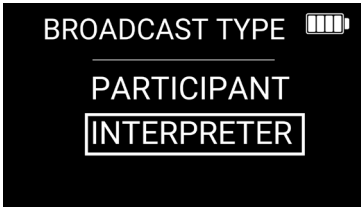

6. CLOCK MODE: As desired (12 HOUR or 24 HOUR)
7. CLOCK: Set current time if desired. All units in the Q&A system will sync their time to the MASTER 1 unit.
8. ADVANCED SETTINGS: In most cases, there is no need to go into advanced settings. If you choose NO, then the programming is done. For more information on Advanced Settings, reference page 12 of the User Manual for more information.
9. Press TALK to turn on the TALK button for the Interpreter unit.

Note: It is possible to program multiple interpreter units for a setting where multiple interpreters take turn interpreting. However, only one interpreter can have their TALK button pressed at the same time. An interpreter unit programmed as MASTER 1 can take over the open mic from an interpreter unit programmed as GUEST. An interpreter unit programmed as a GUEST can't take over the open mic from an interpreter unit programmed as MASTER 1 until the MASTER 1 unit presses the TALK button to make it inactive.

## B. DLT for Delegation

1. Enter programming mode by holding the menu/select button for three seconds, choose your programming language, then select new settings. (Reminder the power button can be used as a back function for mistakes.)
2. MODE: Q&A INTP



3. MASTER/GUEST: MASTER 2.



We recommend programming the DLT for the most important member of the delegation as Master 2. Master 2 is optional, but it enables key delegation members to always have their TALK button on when speaking without risking being bumped off if there are too many open mics in the system. Two open mics are allowed at the same time for each delegation (channel/language) in addition to the interpreter.

4. GROUP #: Choose the same group number as the interpreter.

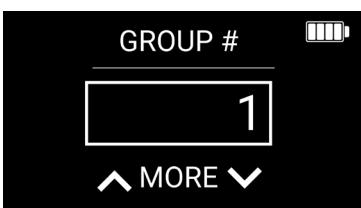

5. BROADCAST TYPE: PARTICIPANT.



6. CHANNEL SELECTION. Choose Channel 01 for the delegation 1 language or Channel 02 for delegation 2 language.

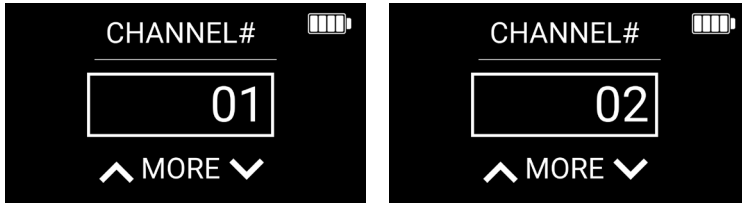

7. CLOCK MODE: As desired (12 HOUR or 24 HOUR)
8. ADVANCED SETTINGS: In most cases, there is no need to go into advanced settings. If you choose NO, then the programming is done. For more information on Advanced Settings, reference page 12 of the User Manual for more information.
9. Press TALK to turn on the TALK button.

**PROGRAMMING ADDITIONAL DELEGATION UNITS.**

Go through the same steps as above for each DLT you would like to program for the delegation. Up to 1024 DLTs can be connected to the overall system. For key members, you can program them as Master 2 units, so that they don't risk being bumped off if somebody else presses their TALK button. Keep in mind that only two microphones may be active at the same time for each delegation (channel/language) (in addition to the interpreter). If you would like to have a set-up where a new delegate is not allowed to "butt in" and talk before another delegate has turned off their TALK button, then program all delegate DLTs as Master 2 units. Unlimited units can be programmed as Master 2.

**C. DLR Programming**

The following steps are for DLRs to be used as listen only devices. DLRs may be used for example for junior delegation members who need to hear the conversation in one of the languages but are not expected to participate.

1. Enter programming mode by holding the menu/select button for three seconds, choose your programming language.
2. SET UP: JOIN GROUP



3. SELECT GROUP: Choose the same group number as the interpreter.

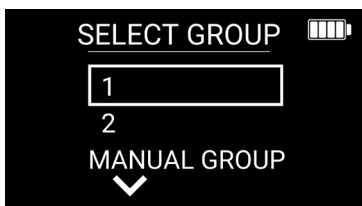

AIM

- Channel: The DLR will be on channel 01. Participant can choose to listen to delegation 1 or delegation 2 language. Use the arrow up button to go to CH 02 if desired.

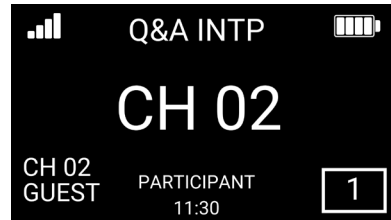
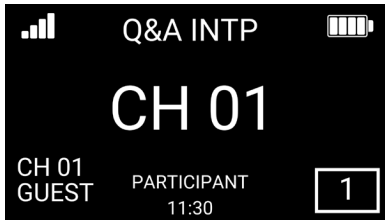

AIM

### Scenario 3: Bilingual Two-Way Tour

Q&A Mode can be utilized in bilingual two-way tours to enable all participants to freely ask questions in their language to be interpreted back to the tour leader.

Q&A Interpretation mode supports two languages. CH01 is the language of the tour leader(s) and possibly some of the tour participants. CH02 is the language of tour participants who require interpretation into another language. Two microphones can be active for each language at any one time, enabling two tour leaders to speak seamlessly at the same time while the interpreter interprets into the other language.

The interpreter will listen to the audio feed from both CH01 and CH02 simultaneously. The interpreter will toggle their output between CH01 and CH02 depending on which language they are currently interpreting in. When interpreting from the tour leader’s language into the tour participant’s target language, output CH02 will be active on the interpreter DLT. When interpreting questions from the tour participants back to the tour leader, output CH01 will be active on the interpreter DLT.

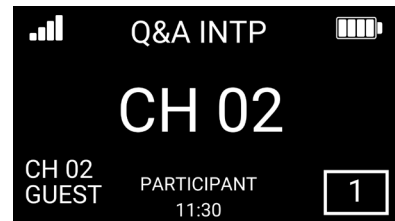
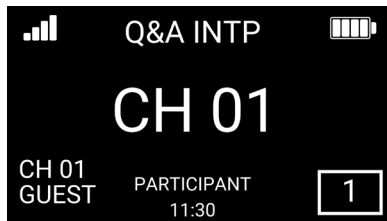

Interpreter output: CH02

Interpreter output: CH01

### Devices required for Scenario 3: Bilingual Two-Way Tour

- 1 x DLT 400-AIM for Interpreter: Broadcast Type: Interpreter – Master 1- Channels 01 & 02 automatically monitored, can switch output between Channels 01 & 02
- 1 or more x DLT 400-AIM for tour leader: Broadcast Type: Participant - Guest or Master 2 – Channel 01
- 1 or more x DLT 400-AIM for tour participants: Broadcast Type: Participant - Guest or Master 2 – Channel 02
- Optional: 1 or more x DLR 400 RCH for listen only participants: Channel 01 or 2

### A.Interpreter DLT Programming

- Enter programming mode by holding the menu/select button for three seconds, choose your programming language, then select new settings. (Reminder the power button can be used as a back function for mistakes.)
- MODE: Q&A INTP

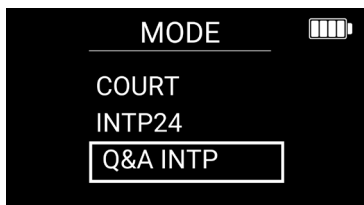

3. MASTER/GUEST: Master 1. This selection is usually recommended for the interpreter. Every Q&A system requires exactly one Master 1. Master 2 is optional.

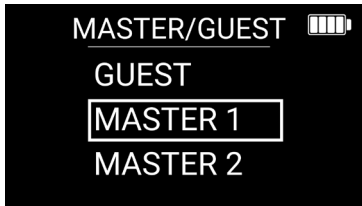

4. GROUP #: Choose a group number. All DLTs and DLRs in the Q&A system need to be connected to the same group.

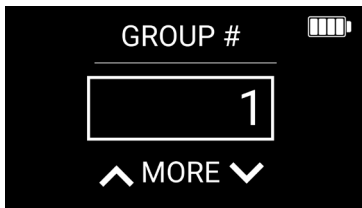

5. BROADCAST TYPE: INTERPRETER



6. CLOCK MODE: As desired (12 HOUR or 24 HOUR)
7. CLOCK: Set current time if desired. All units in the Q&A system will sync their time to the MASTER1 unit.
8. ADVANCED SETTINGS: In most cases, there is no need to go into advanced settings. If you choose NO, then the programming is done. For more information on Advanced Settings, reference page 12 of the User Manual for more information.
9. Press TALK to turn on the TALK button for the Interpreter unit.

## B.Tour Leader DLT Programming

1. Enter programming mode by holding the menu/select button for three seconds, choose your programming language, then select new settings. (Reminder the power button can be used as a back function for mistakes.)
2. MODE: Q&A INTP



3. MASTER/GUEST: MASTER 2.

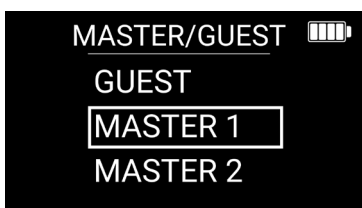

AIM



- We recommend programming the Tour Leader Tour as Master 2. Master 2 is optional, but it enables the tour leader to always have their TALK button on without risking being bumped off if there are too many open mics in the system. Two open microphones are allowed at the same time for the tour leader channel/language (in addition to the interpreter).

4. GROUP #: Choose the same group number as the interpreter.



5. BROADCAST TYPE: PARTICIPANT.

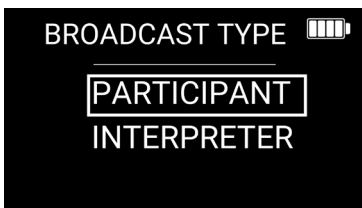

6. CHANNEL: 01. Choose Channel 01 for the Tour Leader language.



7. CLOCK MODE: As desired (12 HOUR or 24 HOUR)
8. ADVANCED SETTINGS: In most cases, there is no need to go into advanced settings. If you choose NO, then the programming is done. For more information on Advanced Settings, reference page 12 of the User Manual for more information.
9. Press TALK to turn on the TALK button.

## PROGRAMMING ADDITIONAL TOUR LEADER UNITS

Go through the same steps as above for each DLT you would like to program for the additional tour leaders. You may program an unlimited number of Master 2 units for tour leaders, so that they don't risk being bumped off if somebody else presses their TALK button. However, keep in mind that only two microphones may be active at the same time for the tour leader channel/language (in addition to the interpreter).

### C. DLT Programming for Tour Participants Requiring Interpretation

1. Enter programming mode by holding the menu/select button for three seconds, choose your programming language, then select new settings. (Reminder the power button can be used as a back function for mistakes.)
2. MODE: Q&A INTP

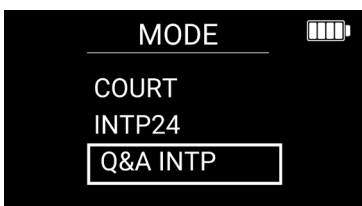

## 3. MASTER/GUEST: GUEST or MASTER 2.

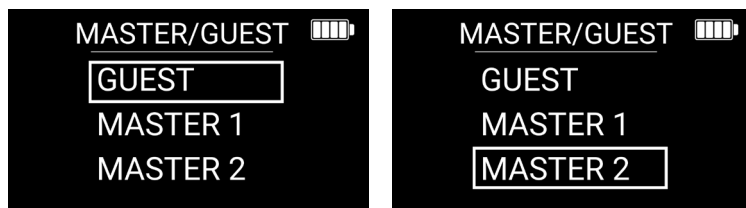

- When to choose: Master 2 or Guest: Choose Master 2 if VIP guest who may need to control the mic, Choose Guest for participants in general.
- Typically, Tour Participant DLTs would be programmed as GUEST units. However, VIP participant DLTs may be programmed as Master 2. Master 2 is optional, but it enables the VIP participants to turn on their TALK button without risking being bumped off if there are too many open mics in the system. Two open microphones are allowed at the same time for the interpreted channel/language (in addition to the interpreter).

## 4. GROUP #: Choose the same group number as the interpreter.



## 5. BROADCAST TYPE: PARTICIPANT.



## 6. CHANNEL: 02. Choose Channel 02 for the Tour Participant Interpreted Target language.



7. CLOCK MODE: As desired (12 HOUR or 24 HOUR)
8. ADVANCED SETTINGS: In most cases, there is no need to go into advanced settings. If you choose NO, then the programming is done. For more information on Advanced Settings, reference page 12 of the User Manual for more information.
9. Press TALK to turn on the TALK button.

## PROGRAMMING ADDITIONAL PARTICIPANT UNITS

Go through the same steps as above for each DLT you would like to program for the additional participants.

### D. Tour Participants Using the Same Language as the Tour Leader DLT Programming (Optional)

1. Enter programming mode by holding the menu/select button for three seconds, choose your

programming language, then select new settings. (Reminder the power button can be used as a back function for mistakes.)

2. MODE: Q&A INTP



3. MASTER/GUEST: GUEST or MASTER 2.



- Typically, Tour Participants would be programmed as GUEST units. However, VIP participant DLTs may be programmed as Master 2. Master 2 is optional, but it enables the VIP participants to turn on their TALK button without risking being bumped off if there are too many open mics in the system. Two open microphones are allowed at the same time for the interpreted channel/language (in addition to the interpreter).

4. GROUP #: Choose the same group number as the interpreter.

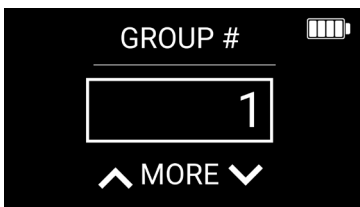

5. BROADCAST TYPE: PARTICIPANT.



6. CHANNEL: 01. Choose Channel 01 for the Tour Leader language.



7. CLOCK MODE: As desired (12 HOUR or 24 HOUR)
8. ADVANCED SETTINGS: In most cases, there is no need to go into advanced settings. If you choose NO, then the programming is done. For more information on Advanced Settings, reference page 12 of the User Manual for more information.
1. Press TALK to turn on the TALK button.
2. PROGRAMMING ADDITIONAL PARTICIPANT UNITS: Go through the same steps as above for each DLT you would like to program for the additional participants.

### E. DLR (Listen Only) Programming (Optional)

The following steps are for DLRs to be used as listen only devices. DLRs may be used for tour participants who need to hear the conversation in one of the languages but are not expected to participate.

1. Enter programming mode by holding the menu/select button for three seconds, choose your programming language.
2. SET UP: JOIN GROUP

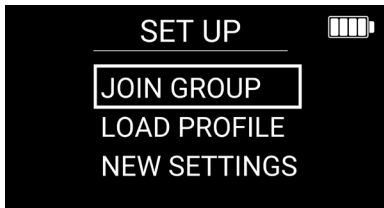

3. SELECT GROUP: Choose the same group number as the interpreter.

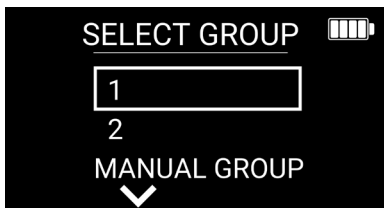

4. The DLR will be on channel 01. Use the arrow up button to go to channel 02 if desired.

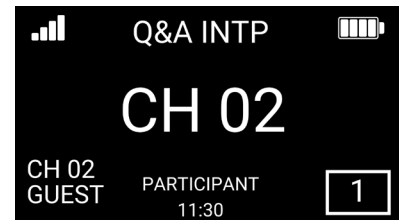
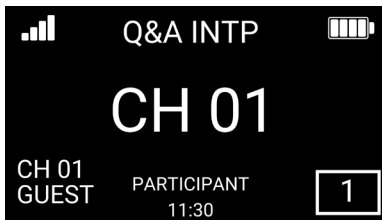

AIM

## 24-Channel Interpretation Mode

24-channel mode is intended mainly for large interpretation conferences. As the name implies, it allows for 24 channels/languages instead of the floor + 14 languages supported in standard interpretation mode. One difference compared to Digi-Wave® standard interpretation mode is that the 24-channel mode is a pure one-way mode. This means that an interpreter DLT on one of the channels works as a transmitter only. An interpreter using a DLT can't hear the floor language directly through the DLT. Instead, the interpreter would typically use an interpreter console such as the IC-2 to hear the floor language.



Devices required for 24-channel mode

1. 1 x DLT 400-AIM for Interpreter: Broadcast Type: Interpreter – Master Channel 01
2. 1 or more x DLT 400-AIM for Interpreters languages 02-24: Broadcast Type: Interpreter – Master – Channel 02-24
3. 1 or more x DLR 400 RCH for listen only participants: Channels 01-24
4. Optional: 1 or more x DLT 400-AIM as repeater units: Broadcast Type: Repeater – Guest – Channel 01-24

## Programming for 24-Channel Interpretation

### A. Interpreter DLT Programming

1. Enter programming mode by holding the menu/select button for three seconds, choose your programming language, then select new settings. (Reminder the power button can be used as a back function for mistakes.)
2. MODE: INTP14



3. MASTER/GUEST: MASTER. One (and only one) interpreter DLT has to be set up as MASTER. The other interpreter DLTs have to be set up as GUEST.



4. GROUP #: Choose a group number. All DLTs and DLRs in the INTP24 system need to be connected to the same group.



- BROADCAST TYPE: INTERPRETER. Repeater units can be added to add range. Max. 1 repeater unit per channel is allowed.

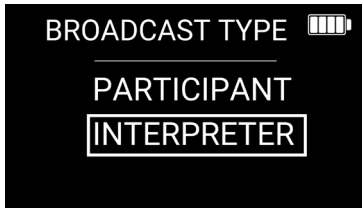

- CHANNEL: 01. Choose channel 01 for the first channel. Additional interpreter DLTs will be on channels 02-24.



- CLOCK MODE: As desired (12 HOUR or 24 HOUR)
- CLOCK: Set current time if desired. All units in the system will sync their time to the MASTER unit.
- ADVANCED SETTINGS: In most cases, there is no need to go into advanced settings. If you choose NO, then the programming is done. For more information on Advanced Settings, reference page 12 of the User Manual for more information.
- The TALK button will automatically be turned on, the first interpreter unit is ready.

### ADDITIONAL INTERPRETER DLT UNITS:

Program additional interpreter DLT units in the same manner on channels 02-24 as GUEST units.

### B. DLR (Listen Only) Programming

The following steps are for DLRs to be used for the audience to listen to interpreted languages.

- Enter programming mode by holding the menu/select button for three seconds and choose your programming language.
- SET UP: JOIN GROUP

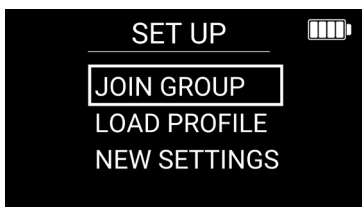

- SELECT GROUP: Choose the same group number as the interpreter.

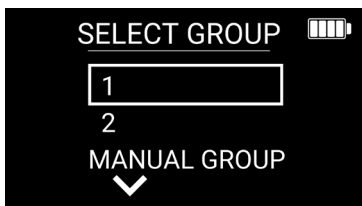

The DLR will be on channel 01. Use the arrow up button to go to channel 02-24 if desired. Hold the arrow up button to seek for active channels.

# Control Function

A DLT 400-AIM device can be programmed as a CONTROL unit. This enables channel naming and sub-groups to be set up offline. The control function makes it possible to make changes to a Digi-Wave® system without interrupting an ongoing event. The control unit is synced to the MASTER when convenient, for example during a break. All other DLTs and DLRs (RCH only) then inherit channel names and sub-group information from the master unit. Channel naming and sub-group programming is only available through a DLT programmed as a CONTROL unit.

The DLT 400-AIM functionality enables a CONTROL unit to be set up for all the interpretation modes:

- **INTERPRET.** (Standard interpretation mode incl. BILINGUAL and RELAY)
- **INTP24** (24-channel interpretation mode)
- **Q&A INTP** (Interpretation with Question & Answer)

DLT 400-AIM does not enable channel naming and sub-groups for other Digi-Wave® modes such as Tour, Hearing Assist, Intercom and Court mode).

See the sections “Channel Naming” and “Sub-Groups” for details on CONTROL unit programming.

### CONTROL UNIT EXAMPLE:

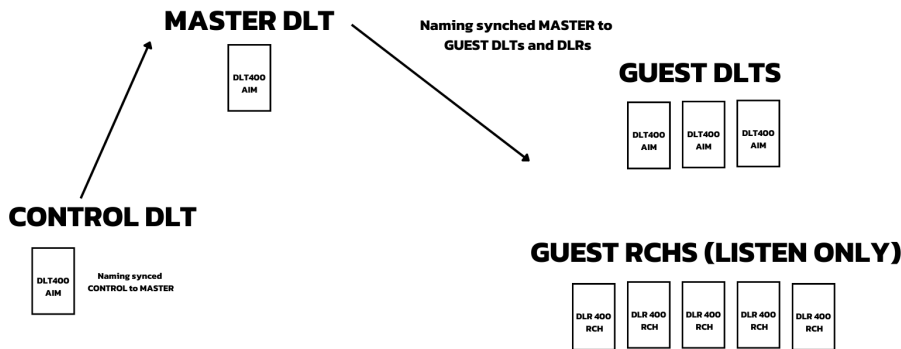

# Channel Naming

The channel name can be any 3-letter ISO language abbreviation out of 100 common languages; OR custom 5-character names (letters, numbers, blank). Channel naming is done on a DLT programmed as a CONTROL unit. The control unit is synced to the MASTER when convenient. All other DLTs and DLRs (RCH only) then inherit channel names from the master unit. See the document “AIM List of Channel Names” for details on which channel names are available.

## Programming Channel Names

1. Enter programming mode by holding the menu/select button for three seconds, choose your programming language, then select new settings.
2. MODE: INTERPRET, INTP24 or Q&A INTP.



3. Make sure you choose the same mode as the MASTER unit of the Digi-Wave® system. If the modes aren't the same, then the Control unit will not be able to synchronize with the Master unit.
4. MASTER/GUEST?: CONTROL.



5. GROUP #: Choose the same group number as the MASTER 1 of the system you wish to update.



6. SETUP SUBGROUP: NO. Select NO if you don't wish to set up a subgroup. See the SUBGROUP section for details on setting up subgroups.

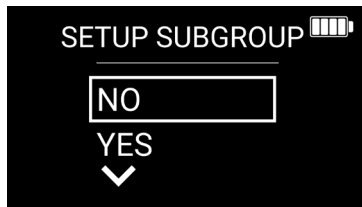

7. Select a CH01 NAME: The options include: 01, CUSTOM or ISO CODE. (For standard interpretation mode, you can also program the channel 0 (floor language) name.)



If you keep 01 as the channel name, then you move to channel name programming for channel 02.

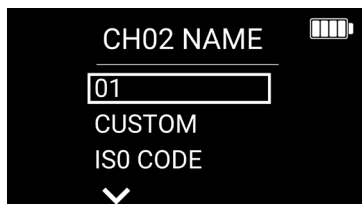



**If you choose ISO CODE,**

Then, the next screen is: CH01 REGION: WORLD, EUR/AM, INDIA/SA. Choose region and then 3-letter language code for desired language.

**If you choose CUSTOM,**

- Then the next screen is LETTER 1-5: Choose between the letters in the English Alphabet, blank and 0-9. Program 5 letters for Channel 01. (Reminder the power button can be used as a back function for mistakes.)

8. Once you have programmed the name for Channel 01, then the next step is Choosing Channel 02 (CH02) NAME: Same process as for Channel 01 name. You may name all the channels available for the interpretation mode you are programming. If you don't have a name for all the channels, then you may jump to the end of programming by holding the enter button for three seconds. (Unprogrammed channel names keep the default number as their name.)
9. SAVE: SAVE, SAVE AS PROFILE or CANCEL.
  - Choose SAVE if you are ready to update the system now or soon.
  - Choose SAVE AS PROFILE if you are planning to update the system at a later date and you may use the same DLT for other purposes between now and then.
10. UPDATE SYSTEM: NO or UPDATE SYSTEM NOW.
  - Choose NO if you want to save your settings, but you are not ready to update the system.
  - Choose UPDATE SYSTEM NOW if you are ready to synchronize with the MASTER and all DLTs and DLRs connected to that group.
11. UPDATE SYSTEM ARE YOU SURE? Choose UPDATE SYSTEM NOW to go ahead with the update.
  - A bar showing the progress of the UPDATE will be visible both on the CONTROL units and the MASTER unit. Once the update has been done a pop-up window showing UPDATE OK will be visible on the control and master units. Channel naming will then be pushed out to all DLTs and DLRs which are connected to the group. Note: DLTs and DLRs need to be connected to the MASTER unit (within radio range and turned on) when the update is done in order to be updated.

**Verifying Channel Names**

The current channel names programmed for the CONTROL unit are listed at the bottom of the display. You can go scroll through the channels to see the names by using the up/down arrows.

## Channel Sub-Groups

Channel subgroups are helpful in a situation where you don't want all the channels to be visible to all participants. For example, this may be the case when a large hall is sometimes divided into two or more

separate spaces. You can also utilize sub-groups to limit the number of channels visible on the receivers. For example, if only channels 01-16 are active in 24-channel mode, then you could set up a subgroup for channels 01-16 and program the DLRs to be in that subgroup for the receivers to avoid seeing non-active channels.

### Programming Sub-Groups

1. Enter programming mode by holding the menu/select button for three seconds, choose your programming language, then select new settings.
2. MODE: Select INTERPRET, INTP24 or Q&A INTP.
  - Make sure you choose the same mode as the MASTER unit of the Digi-Wave® system. If the modes aren't the same, then the Control unit won't be able to synchronize with the Master unit.
3. MASTER/GUEST?: Select CONTROL.



4. GROUP #: Choose the same group number as the MASTER of the system you wish to update.
5. SETUP SUBGROUP: YES.

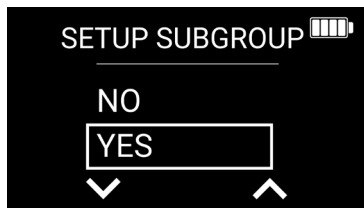

6. SUBGROUP 1 - 1ST CHANNEL: CH 00-CH 14 for standard interpretation,

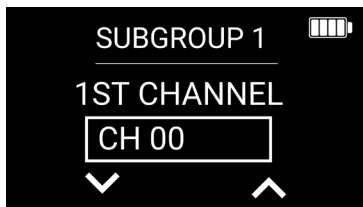

- CH 01-CH24 for INTP24.

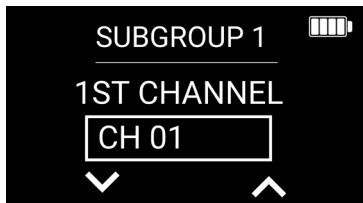

- SUBGROUP 1 - LAST CHANNEL: CH 00-CH 14 for standard interpretation,

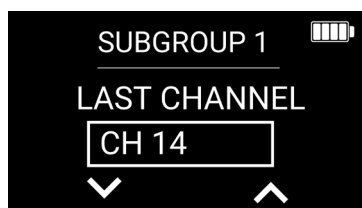
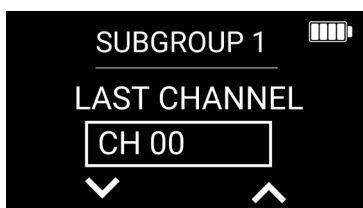

- CH 01-CH24 for INTP24.

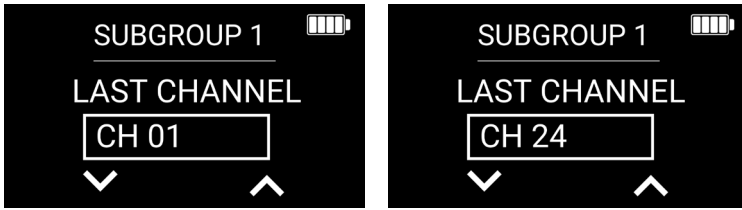

**You must choose a higher number for the last channel than the first channel.**

- SUBGROUP 2 - 1ST CHANNEL: CH 00-CH 14 for standard interpretation, CH 01-CH24 for INTP24. You must program at least two subgroups in order to use the sub-group feature. There can be overlap between the different subgroups. For example, you could have channels 01-05 for subgroup 1 and channels 03-08 for subgroup 2.
- SUBGROUP 2 - LAST CHANNEL: CH 00-CH 14 for standard interpretation, CH 01-CH24 for INTP24. You must choose a higher number for the last channel than the first channel.
- ADD SUBGROUP 3: NO or YES. Optional.
- ADD SUBGROUP 4: NO or YES. Optional.
- ACTIVE SUBGROUP: NO or YES. If you would like to update subgroups as soon as you update the system, choose YES. If subgroups were previously active, the way to deactivate them is to go to this programming step and choose ACTIVE SUBGROUP = NO and then update the system.
- After adding 2-4 subgroups, you are taken to the channel naming menu. See Channel Naming section for details. If you don't want to name the channels, then you may jump to the end of programming by holding the enter button for three seconds. (Channel names will then have the default number as their name.)
- SAVE: SAVE, SAVE AS PROFILE or CANCEL.
  - Choose SAVE if you are ready to update the system now or soon.
  - Choose SAVE AS PROFILE if you are planning to update the system at a later date and you may use the same DLT for other purposes between now and then.
- UPDATE SYSTEM: NO or UPDATE SYSTEM NOW.
  - Choose NO if you want to save your settings, but you're not ready to update the system.
  - Choose UPDATE SYSTEM NOW if you are ready to synchronize with the MASTER and all DLTs and DLRs connected to that group.
- UPDATE SYSTEM ARE YOU SURE?: Choose UPDATE SYSTEM NOW to go ahead with the update.
  - A bar showing the progress of the UPDATE will be visible both on the CONTROL units and the MASTER unit. Once the update has been done a pop-up window showing UPDATE OK will be visible on the control and master units. Channel naming will then be pushed out to all DLTs and DLRs which are connected to the group. Note: DLTs and DLRs need to be connected to the MASTER unit (within radio range and turned on) when the update is done in order to be updated.



## Programming DLR (Listen Only) units for Sub-Groups

1. Enter programming mode by holding the menu/select button for three seconds, choose your programming language, then select new settings.
2. MODE: INTERPRET, INTP24 or Q&A INTP.
3. GROUP #: Choose the same group number as the MASTER unit.
4. SUBGROUPS?: NO, SG1, SG2, SG3, SG4.
5. This determines which sub-group the DLR belongs to, meaning which channels it can listen to. If you choose NO, then the DLR will have access to all channels (00-14 in standard interpretation mode, 01-24 in 24-channel mode).
  - If you don't want to go through additional options, hold the menu/select button for three seconds – you will then finish programming and your DLR is now active within the chosen sub-group. (You may also go through the additional options of tone, line-out gain, encryption and PIN code.)
  - The DLR will be on the lowest channel of the sub-group. Use the arrow up button to go to channel 02-24 if desired. Hold the arrow up button to seek for active channels. The DLR will show which sub-group it is in the middle of the screen below the channel name if sub-groups are active.

## Verifying Sub-Groups

You can verify which sub-groups are set up on a CONTROL unit by quickly pressing the menu/select button several times. The pop-up window will first show the group number and firmware version. If you click the menu/select button several more times, then it will show the different sub-groups.

# Advanced Comms Module (ACM)

## Advanced Comms Module (ACM) Overview

- Compatibility
- Advanced Comms Mode Overview
- Operating an Advanced Comms System
  - Switching Sub-groups
  - All-Call Function
  - Push and Latch vs. Push to Talk
  - Open microphones
  - Private call
  - DLR 400 RCH Listen Only Receivers
- Main Principles of Programming an Advanced Comms System
- MAIN SYNC vs Communication Role
- Programming Instructions
  - Scenario 1: The leader or a group member is the MAIN SYNC
  - Programming optional DLR 400 RCH units
  - Scenario 2: MAIN SYNC is mounted in a fixed location
  - Programming a control unit

ACM

## Advanced Comms Module (ACM) Overview

The Advanced Comms Module (ACM) introduces the following new features to a Digi-Wave® system in the new Advanced Comms Mode:

- Sub-Groups for fast, seamless switching
- All-Call Functionality
- Flexible Synchronization Functionality
- Sub-Group Naming

Advanced Comms Module (ACM) Features are only available for the DLT 400-ACM variant of the DLT 400 transceiver. To check if your DLT is the ACM variant, check if the word “ACM” is present under the battery symbol on the display. Contact your local Williams AV representative regarding upgrade paths to the DLT 400-ACM variant.

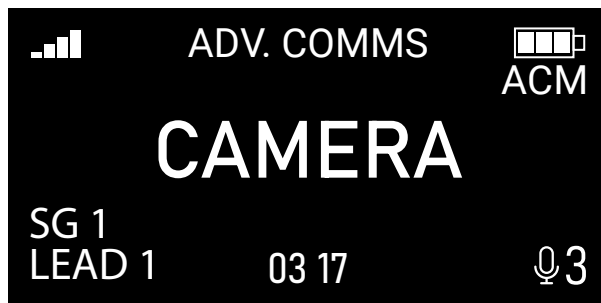

### Compatibility

- DLR 400 RCH units on firmware version 1.4.1 or higher are compatible. Contact your Williams AV representative to upgrade your firmware.
- DLR 400 ALK units are not compatible with the special ACM features.

## Advanced Comms Mode

Advanced Comms mode facilitates efficient and flexible communication between a Leader and several teams. In the Advanced Comms mode, a Leader (LEAD 1 communication role and optionally, the LEAD 2 role) can quickly and seamlessly switch between up to 4 teams (sub-groups). The sub-groups can be named using a standard list of commonly used team functions or with a custom name of up to six characters.

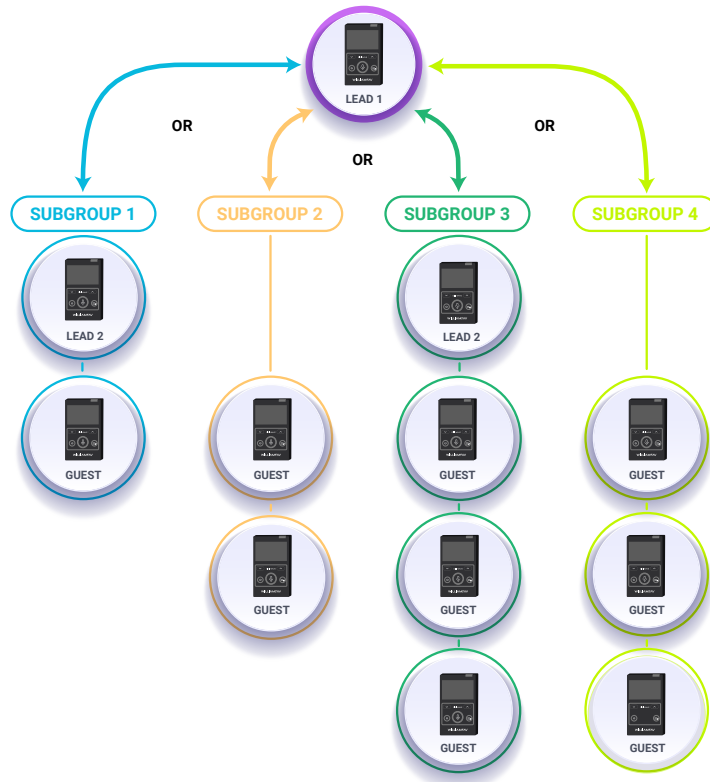

Advanced Comms mode also includes All-Call functionality. All-Call enables a Leader (LEAD 1 and optionally, LEAD 2) to pause all communication across up to 4 subgroups and address all units simultaneously.

Advanced Comms mode allows any DLT 400 transceiver in the system to be programmed as the MAIN SYNC unit and act like a flexible access point to maximize coverage range. The Advanced Comms Mode allows for a DLT 400 to be programmed as a Control unit to support situations where the MAIN SYNC unit is permanently mounted in an inaccessible location. System programming can be done on the control unit and then updated by connecting wirelessly to the system. The Control unit offline programming can also be used to quickly make changes to a system without interrupting an event.

### Devices Required for Advanced Comms Mode:

- 1 x DLT 400-ACM for Leader (Communication Role: LEAD 1)
- 1 or more x DLT 400-ACM for Team Members (Communication Role: Guest)] of the DLT-400-ACM unit in the system (any communication role) must be designated with Sync Role: Main Sync.

### Optional:

- DLT-ACM for Assisting Leaders (Communication Role: LEAD 2)
- DLT-ACM for Offline Programming (Sync Role: Control)
- DLR 400 RCH for Listen only units (No Sync or Communication Role)

## Operating an Advanced Comms System

### Switching subgroups

To switch subgroups, LEAD 1 or (or LEAD2 as applicable) can hit the up or down arrows to switch into each subgroup and participate in that discussion. All subgroups (up to 4) are available to the LEAD 1 communication roles. You can also set up LEAD 2 units to access several or all sub-groups if desired.

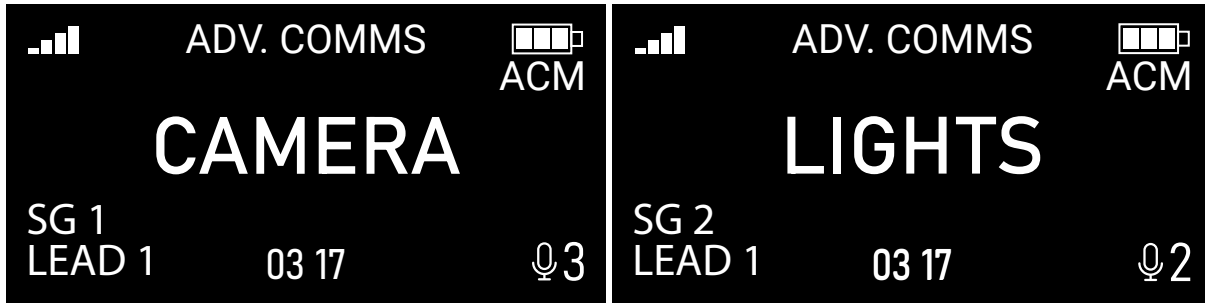

### All-Call function

The LEAD 1 unit can address all subgroups simultaneously through the all-call function. A LEAD 1 device will initiate all-call by holding down the talk button. All other devices' talk buttons will start blinking, and all displays will indicate "ALL." (Flashing can be turned off in advanced settings if desired.) Only LEAD 1 unit can speak (except if talk-back during all-call has been set up to be allowed). You can also set a system up to enable LEAD 2 units to initiate all-call. The all-call function is ended by the unit that initiated the all-call by tapping the TALK button. All devices now return to the subgroup they were previously in.

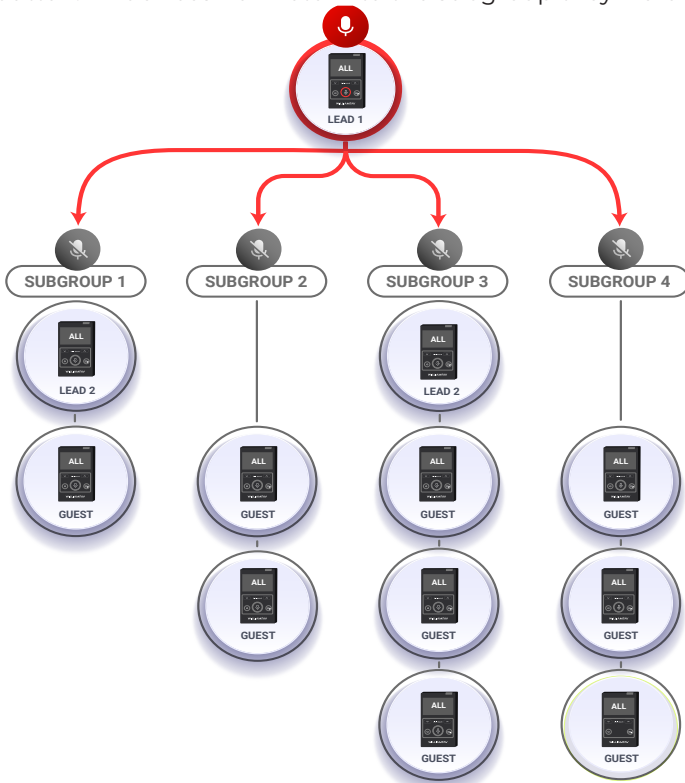

1. Hold down the talk button to activate All-Call. The DLT 400-ACM-ACM units in the same group as the activated DLT 400-ACM will now be muted.
2. The DLT 400-ACM and DLR 400 units in the same group will display the word ALL and the DLT 400-ACM ACM units talk buttons will be flashing.

## Push and Latch vs. Push to Talk

LEAD 1 and LEAD 2 units operate with Push and Latch, meaning that a tap on the talk button turns it on until it is again tapped and turned off. LEAD 1 (and optionally LEAD 2) can hold the talk button to initiate all-call. GUEST units can activate push and latch to the TALK button by tapping it. The TALK button will now be turned on until they tap it again to turn it off. If a GUEST unit instead holds the talk button, now it will only be turned on until they let go (push to talk).

## Open Microphones

In each subgroup, 6 devices can speak simultaneously in a complete duplex manner by activating their talk buttons. If a 7<sup>th</sup> device joins, then the first GUEST unit which activated their talk button will have it deactivated according to a first in first out philosophy. LEAD 1 and LEAD 2 are always allowed to TALK; their TALK buttons will remain on even if an additional unit starts talking. Please note that there is no limit to the number of LEAD 2 units that can be programmed. If there are 7 or more LEAD 1 and LEAD 2 units in a subgroup, only 6 units can talk simultaneously. If additional units try to press their talk button, they will receive the message "LINK FULL," their talk button will not be turned on.

In all-call mode, typically, only LEAD 1 can talk. If talk-back in all-call is allowed, then 6 open mics is the maximum and the same rules as described above apply.

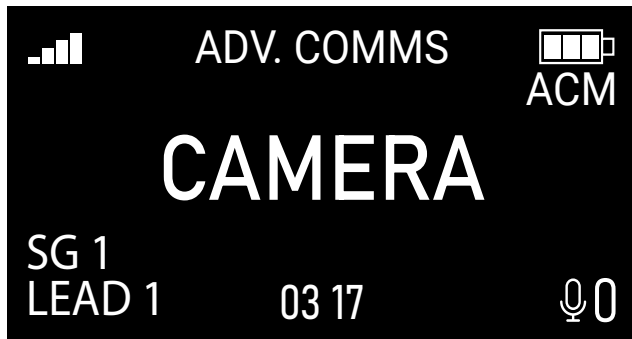

## Private Call

In Advanced Comms mode a LEAD 2 unit can make a PRIVATE call with the LEAD 1. LEAD 2 units see PRIVATE as a subgroup and can navigate to it using the arrow up/down buttons. To avoid mistakes, the private call with LEAD 1 is not activated until the unit presses the TALK button. This then established a private call between the initiating unit and LEAD 1. At that point, no other units can access the LEAD 1 keeping the conversation private.

A private call is ended by the initiating unit tapping the talk button. Both this unit and the LEAD 1 unit now return to their previous subgroup. A LEAD 1 unit can also terminate the private call by navigating to another subgroup (using the arrow buttons) or initiating all-call (by holding the talk button). The PRIVATE call function can be turned off in programming if desired. It is also possible to allow GUEST units to initiate PRIVATE calls.



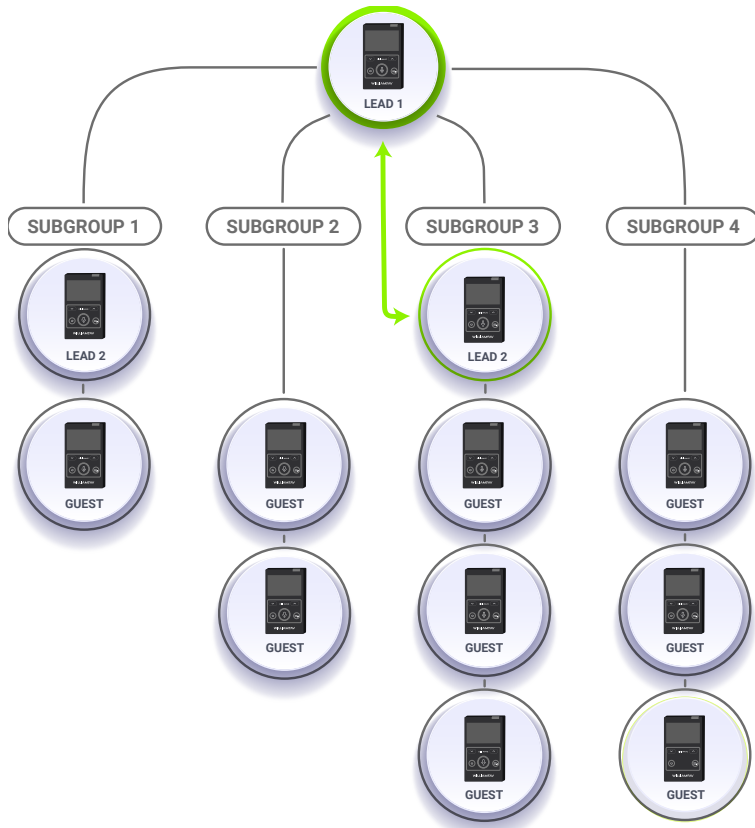

## DLR 400 RCH Listen Only Receivers

Most commonly, an Advanced Comms system will consist of only transceiver units. However, it could be appropriate and helpful in certain circumstances to include DLR 400 RCH listen only receivers. A DLR 400 RCH can listen to one subgroup but cannot talk. When all-call is initiated, they will join the all-call group and hear that audio. The only adjustments that can be made on a DLR 400 RCH in an active system are volume and tone control.

## Main Principles of Programming an Advanced Comms System

This section explains the main communication and sync roles for DLT 400-ACM units in a system and gives general guidance for system set-up. For step-by-step instructions, see the section Programming Instructions.

### Communication Role: LEAD 1

1 DLT 400-ACM can be designated as LEAD 1. This unit can switch between all active sub-groups and address them simultaneously using the All-Call functionality. The LEAD 1 unit must be designated by programming the actual device as LEAD 1.

### Communication Role: Guest

1 or more DLT 400-ACM can be designated as GUEST. Each guest unit is assigned to one subgroup and can only communicate within this subgroup (unless optional talk-back during all-call is allowed).

### Optional Communication Role: LEAD 2

1 or more DLT 400-ACM units can be designated as LEAD 2. The optional LEAD 2 functionality allows for a lot of flexibility in how a system is set up. LEAD 2 units can be allowed to switch between sub-groups or between a sub-set of sub-groups. They can be allowed to initiate all-call and talk during all-call. LEAD 2 units can initiate a PRIVATE call with LEAD 1.

## Sync Role: MAIN SYNC

Exactly 1 DLT 400-ACM must be designated as MAIN SYNC. The system synchronizes to this unit, so it determines the coverage range. Most aspects of the system set-up are programmed on the MAIN SYNC unit (or an optional CONTROL unit) with other units in the system acting according to permissions set-up in the MAIN SYNC. The MAIN SYNC can either be the same unit as the LEAD 1 or any other unit. For more explanation, see the section Sync Role vs. Communication Role. An M on the display indicates that the device is the MAIN SYNC device.

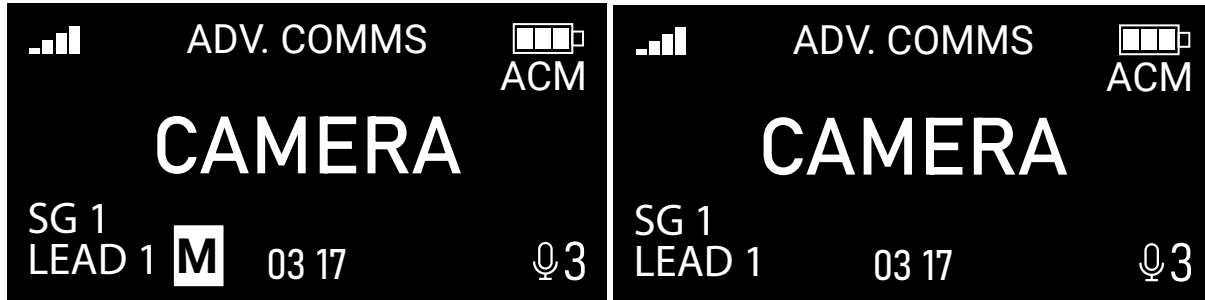

## Sync Role: Node

1 or more DLT 400-ACM can be designated as NODE. All units in a system except for the MAIN SYNC unit (and optionally 1 Control unit) must be designated as a NODE.

## Optional Sync Role: Control

1 DLT 400-ACM can be designated as CONTROL. The optional CONTROL functionality allows for offline programming on a separate unit when the MAIN SYNC is mounted in an inaccessible location – or when an operator desires to prepare changes without interrupting an active system.

## Sync Role vs. Communications Role

MAIN SYNC is a new set-up feature within the Advanced Comms Mode. After selecting Advanced Comms Mode, DLT 400-ACM can be set up within a Sync Role of node, MAIN SYNC, or control independent of the Communication Role. With this new feature set, you can manage the radius or axis to which the DLTs are connected, allowing for a more extensive coverage range for units in the system to connect to. There are two main scenarios for the MAIN SYNC and communication roles depending on where the LEAD 1 and other units are in the space. These scenarios are explained in the Detailed Programming Instructions section

- There must always be exactly 1 MAIN SYNC unit in a group.
- All other DLTs are NODEs (except an optional CONTROL unit)
- All DLTs and DLR 400 RCH units in the system must be within radio distance of the MAIN SYNC unit
- Any DLT can be assigned as MAIN SYNC regardless of communication role (LEAD 1, LEAD 2, or GUEST). In standard intercom mode, Master 1 is the lead communication role and the radio synchronization unit. The same situation is not the case with LEAD1 in Advanced Comms mode. Instead, any unit can be designated as the MAIN SYNC unit.
- MAIN SYNC determines the coverage range of the system. Program a unit located centrally and consistently turned on as MAIN SYNC. For some venues, it may be helpful to permanently mount a MAIN SYNC DLT 400-ACM in a fixed central location, in the ceiling or on the wall. This unit would typically be connected to a Digi-Wave Connect (DWD 401), which provides constant power and flexible mounting options.

## Programming Instructions

### Scenario 1: The Leader or a Team Member is MAIN SYNC

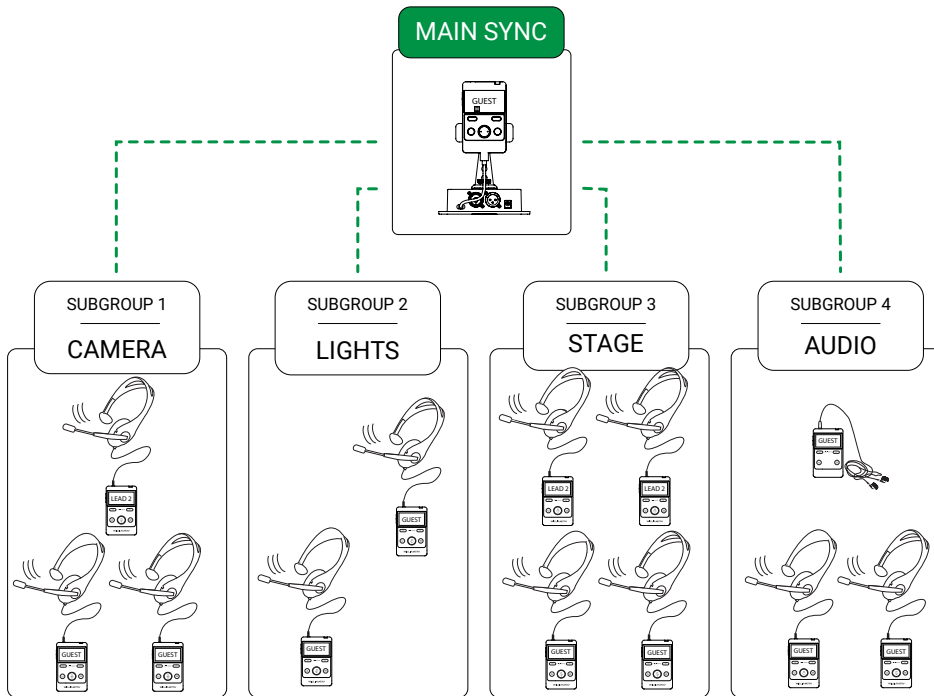

ACM

#### Devices Required for Scenario 1:

- 1 x DLT 400-ACM for Leader: Communication Role: LEAD 1- This unit can switch between all subgroups seamlessly and address them all at once through all-call.
- 1 x or more x DLT 400-ACM for GUEST: Communication Role: Guest – Most units are typically programmed as GUEST and belong in only one sub-group
- Exactly 1 DLT 400-ACM in the group (LEAD 1, LEAD 2 or GUEST) must have the Sync Role MAIN SYNC. This is the unit all other units connect to, so it determines the coverage range of the system. The MAIN SYNC unit must always be turned on when the system is active, it should be centrally located to maximize range. It is not necessary to have an additional unit for MAIN SYNC; it can be any of the units active within the system.

#### Optional

- 1 or more X DLT 400-ACM for LEAD 2 – Communication Role: LEAD 2 – Zero to an unlimited number of LEAD 2 units can be included in a system. LEAD 2 is the most flexible programming role. By default, LEAD 2 units are remarkably like GUEST units. However, they can be programmed to act in a similar manner to LEAD 1 unit, with the ability to switch between some or all subgroups, initiating all-call and talking during all-call.

## A. MAIN SYNC DLT Programming

MAIN SYNC Programming determines the set-up for the entire system. As such, it is much more detailed than programming the other units in a system.

1. Enter programming mode by holding the menu/select button for three seconds, choose your programming language, then select new settings. (The power button can be used as a back function for mistakes.)
2. MODE: Adv. Comms

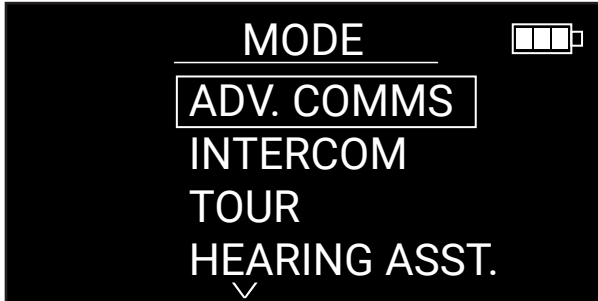

3. Sync role: MAIN SYNC. This selection determines that this device connects all the devices together in a group. The device dedicated as the MAIN SYNC determines the coverage range of the system. Every Adv Comms system requires exactly one MAIN SYNC. The MAIN SYNC can have any communication role (LEAD 1 or 2, or GUEST). (This differs from standard intercom mode, where the Master unit has the main communication role and is the unit all others connect to.)

## B. Communication Role:

- LEAD 1 is usually recommended for the director or leader of the group. LEAD 1 has a special capability, as it can initiate all-call and switch between all the sub-groups.
  - GUEST is the most common communication role. GUEST units can only communicate within one designated sub-group. By default, GUEST units remain muted during all-call and cannot initiate a PRIVATE call with LEAD 1 only (but can be programmed to do so if desired.)
  - LEAD 2 units are optional. LEAD 2 units can be programmed to access several or all sub-groups and to initiate all-call in addition to optionally talk back during all-call and initiate a private call with LEAD 1.
1. GROUP #: Choose a group number. All DLTs and DLRs in the Advanced Comms system need to be connected to the same group.

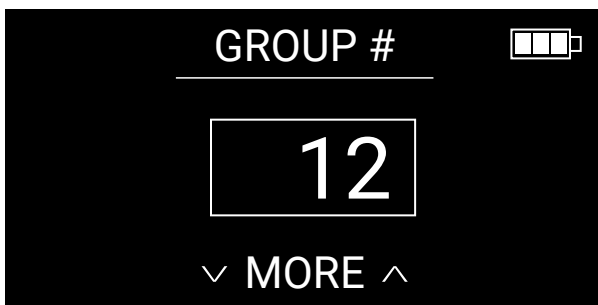

2. Join Sub-group: GUEST units are designated to exactly one sub-group. LEAD 2 units can optionally join additional sub-groups. LEAD 1 units do not have this selection as they are automatically able to join all sub-groups.

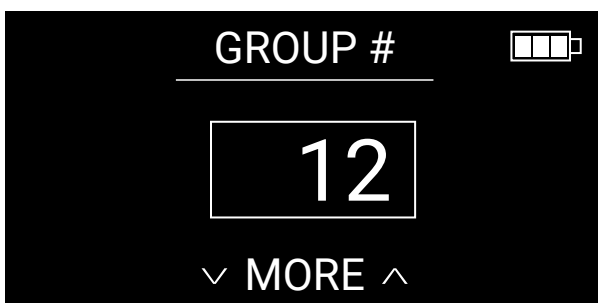

- 3. Initiate all-call: LEAD 1 only is the default setting. It is possible to allow all LEAD 2 units to initiate all-call. It is not possible to allow GUEST units to initiate all-call.

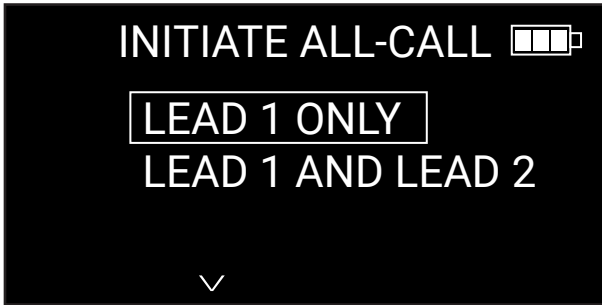

- 3. Talk back in All-Call; NO; The default is "No." LEAD 2 ONLY means that when ALL-CALL is activated, only LEAD 1 and LEAD 2 units can have their mics active. LEAD 2 and GUEST means that all DLTs connected to the system can activate their mics during all-call (max. 6 simultaneous speakers).

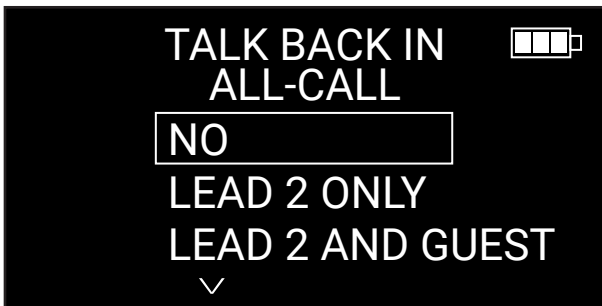

- 4. PRIVATE CALL? LEAD 2 ONLY. Default is "LEAD 2 ONLY". This means that LEAD 2 units can INITIATE A private call to the LEAD 1 unit. This enables a dedicated communication line between this unit and LEAD 1 at any time (during all-call or during general operation). In that case, they will see "PRIVATE" as a sub-group option when using the arrow up/down options during operation. LEAD 2 AND GUEST means that both LEAD 2 and GUEST units can address the LEAD 1. NO means that the PRIVATE call functionality is disabled.

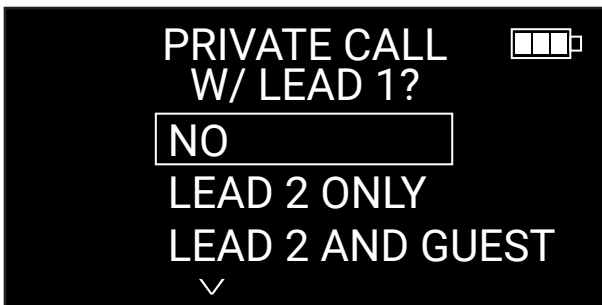

- 6. NO of Subgroups: 4. Default is "4".

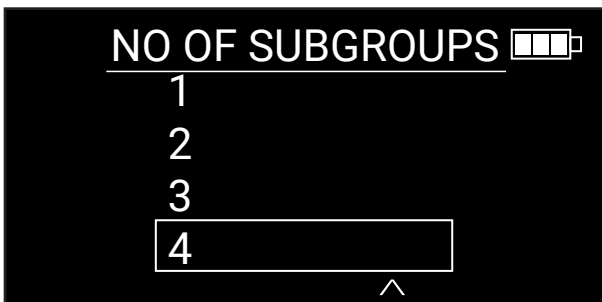

ACM

## Subgroup Naming

The subgroup name can be chosen from a list of common teams, or you can create a custom 6-character name (letters, numbers, blank). Subgroup naming is done on the DLT programmed as MAIN SYNC (or an optional Control unit). All other DLTs and DLRs (RCH only) then inherit subgroup names from the MAIN SYNC unit.

Name subgroups. If no is chosen, then the default names of SG 1, SG 2, SG 3, and SG 4 are active, and the following few steps are skipped. If yes is chosen, there is an opportunity to choose between a list of standard names or program a custom name.

### Programming Subgroup names

1. SG1 Name; Default is "SG 1" If FROM LIST, see next steps. If custom, see following steps

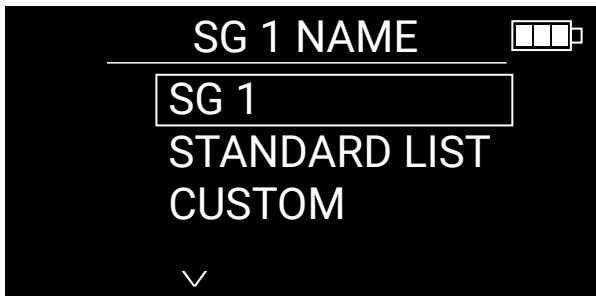

#### Standard List Naming:

1. Using the arrow buttons, you scroll through the list of names
2. After confirming a name for SG 1, then you go to SG 2 name screen (if there are 2 subgroups) and then to SG 3 name screen (if there are 3 subgroups) and then to SG 4 name (if there are 4 subgroups).

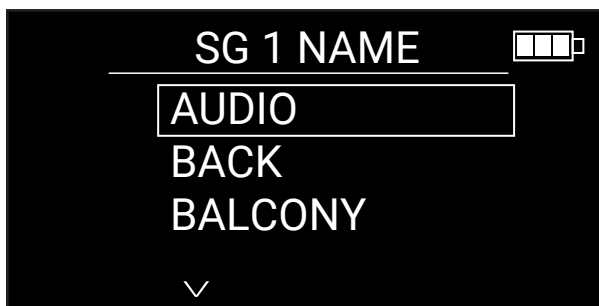

#### Custom Naming:

1. Default is "SG 1". If a custom name is chosen, select the letters and or numbers to create the custom name. MAIN SYNC or CONTROL unit can override naming, whichever is programmed last.
2. Choose 1st letter in name
  - Use up/down buttons to go through all letters, blank and numbers 0-9
  - Repeat the process for a 6-letter custom name
  - During any part of the process, you can go back to the previous letter (if you made a mistake), by the normal procedure of pushing the Power Button quickly.

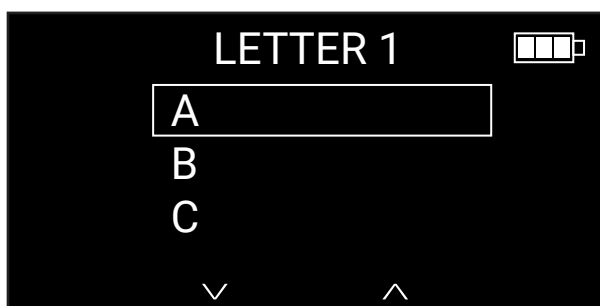

- At the end of the custom naming process, the created name will be shown (in this example "TEAM 1") and there is a choice to accept this or not. If YES is pushed, then you will be taken to the next step in the process. (In this case SG 2 programming.)

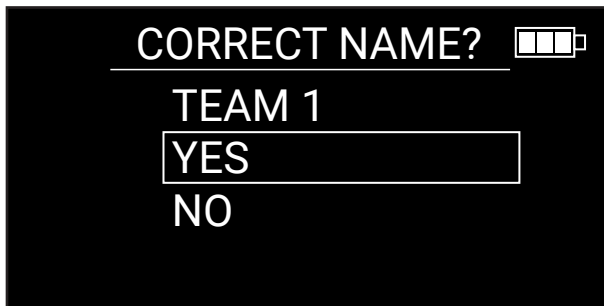

- CLOCK MODE: As desired (12 HOUR or 24 HOUR)
- CLOCK: Set current time if desired. All units in the ACM system will synchronize their time to the Main Sync unit.
- ADVANCED SETTINGS: In most cases, there is no need to go into advanced settings. If you choose NO, then the programming is done. For Adv Comms mode. There is one specific advanced setting you can adjust the talk blink in ALL-CALL to on or off. For more information on Advanced Settings, reference page 12 of the user manual.
- Press TALK to turn on the TALK button for the unit.

### C. NODE DLT Programming

NODE programming only determines this DLT unit's set-up. The system set-up is determined by the programming on the MAIN SYNC unit (or an optional CONTROL unit). As such, it is very quick and easy to program a node unit. All units in a system except for 1 MAIN SYNC unit (and an optional CONTROL unit) should be programmed with the sync role of node.

- Enter programming mode by holding the menu/select button for three seconds, choose your programming language, then select new settings. (Reminder the power button can be used as a back function for mistakes.)
- MODE: Adv. Comm Select adv comm mode
- Communication role: See details under MAIN SYNC programming.
- Group: All node units must connect to the same group as the MAIN SYNC unit.
- Join Sub-group: GUEST units are designated to exactly one sub-group. LEAD 2 units can optionally join additional sub-groups. LEAD 1 units do not have this selection as they can automatically join all sub-groups.
- Clock Mode: Choose either 12 or 24 hour mode.
- Advanced settings. Default is no. There are some unit specific settings that can be applied here. For more information on Advanced settings, visit page 12.

## D. Programming Optional DLR 400 RCH Units

The following steps are for DLRs to be used as listen only units for those who do not need to communicate with the group. Only DLR 400 RCH (not DLR 400 ALK) units can be used in Advanced Comms mode.

1. Enter programming mode by holding the menu/select button for three seconds and choose your programming language. (The power button can be used as a back function for mistakes.)
2. SET UP: New Settings, alternatively if you select Join Group then the DLR will automatically enter subgroup 1.

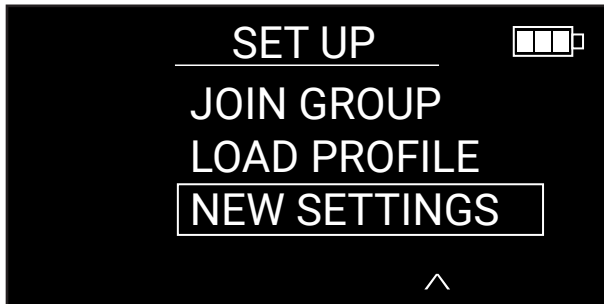

3. Mode: Adv. Comms

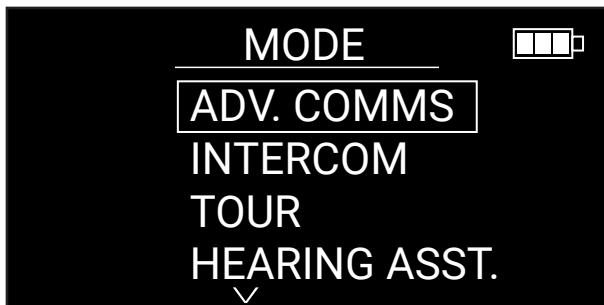

4. SELECT GROUP: Select the intended group.
5. Join Subgroup: Select the subgroup that the DLR (Listen only) unit belongs to. The DLR will be on the subgroup of choice.
6. Additional settings: For details on advanced settings, see page 12 of the manual.



## Programming of Scenario 2: MAIN SYNC is mounted in a Fixed location

In many situations, having the MAIN SYNC in a fixed location provides the best coverage possible for your system. We recommend using a Digi-Wave Connect DWD 401 with the fixed DLT 400-ACM to supply it with constant power and to provide flexible mounting options. If the fixed location is not easily accessible, you can optionally program another unit as a CONTROL unit to change the system settings.

1. Enter programming mode by holding the menu/select button for three seconds, choose your programming language, then select new settings. (Reminder the power button can be used as a back function for mistakes.)
2. MODE: ADV. COMMS
3. Sync role. MAIN SYNC.
4. Communication Role. Guest. Guest is recommended. If the unit is not easily accessible, we do not recommend programming the unit as LEAD 1, since LEAD 1 has specific communication features such as initiating ALL-CALL. See section MAIN SYNC DLT Programming for more details about how to program the unit.
5. Once programming is done, then the system will function within a few seconds when all units have synchronized to the MAIN SYNC unit.

Changes to the system after the initial programming is done can be made by going into programming mode in the MAIN SYNC unit. If the MAIN SYNC unit is in a location not easily accessible, we recommend you dedicate a DLT 400-ACM as a CONTROL unit and do the programming from that unit. A CONTROL unit also enables you to program the system offline while the system is actively functioning.

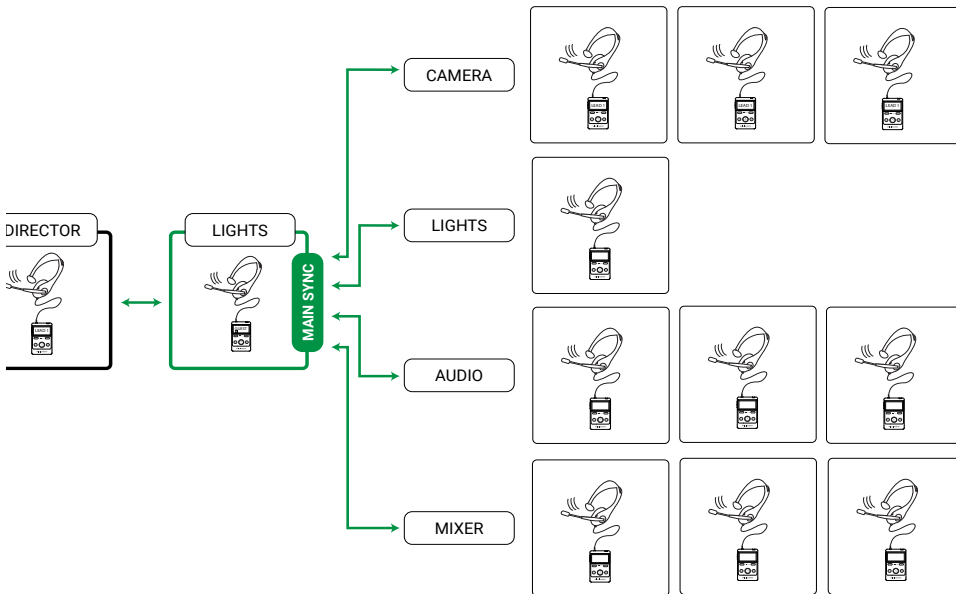

## A. Programming a Control Unit

A DLT 400-ACM device can be programmed as a CONTROL unit. This enables all settings to be set up offline. The control function makes it possible to make changes to a Digi-Wave® system without physically accessing a MAIN SYNC unit and without interrupting an ongoing event. The control unit is synchronized to the MAIN SYNC when convenient, for example, during a break. All other DLTs and DLRs (RCH only) then inherit all system settings from the MAIN SYNC unit.

The DLT 400-ACM functionality enables a CONTROL unit to set up the system in Advanced Comms Mode only. DLT 400-ACM does not enable offline programming, naming and sub-groups for other Digi-Wave® modes such as Tour, Hearing Assist, Intercom, Interpretation and Court mode).

1. Enter programming mode by holding the menu/select button for three seconds, choose your programming language, then select new settings.
2. MODE: ADV COMM
3. SYNC ROLE: CONTROL

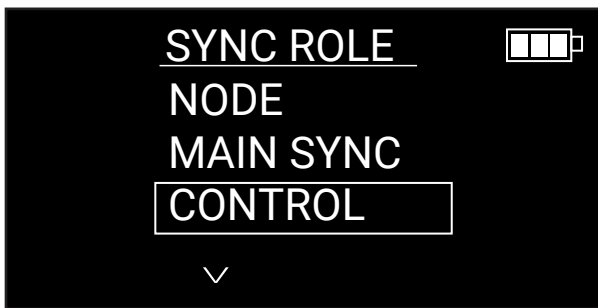

4. GROUP #: Choose the same group number as the MAIN SYNC unit of the system you wish to update. For other programming steps, refer to programming MAIN SYNC for more detail.
5. SAVE: SAVE, SAVE AS PROFILE or CANCEL. Choose SAVE if you are ready to update the system now or soon. Choose SAVE AS PROFILE if you plan to update the system later and you may use the same DLT for other purposes between now and then.
6. UPDATE SYSTEM: NO or UPDATE SYSTEM NOW. Choose NO if you want to save your settings, but you are not ready to update the system. Choose UPDATE SYSTEM NOW if you are ready to synchronize with the MAIN SYNC unit and all DLTs and optional DLRs connected to that group.
7. UPDATE SYSTEM ARE YOU SURE? Choose UPDATE SYSTEM NOW to go ahead with the update. A bar showing the progress of the UPDATE will be visible both on the CONTROL units and the MAIN SYNC unit. Once the update has been done, a pop-up window showing UPDATE OK will be visible on the control and MAIN SYNC units. Updated system settings will be pushed out to all DLTs and optional DLRs connected to the group. Note: DLTs and optional DLRs must be connected to the MAIN SYNC unit (within synchronization radio range and turned on) when the update is done to be updated.

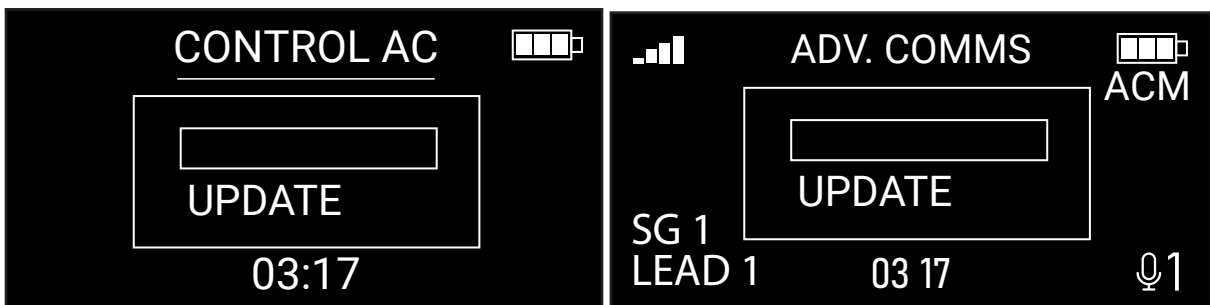

### Verifying Subgroup Names

The current channel names programmed for the CONTROL unit are listed at the bottom of the display. You can scroll through the subgroups to see the names by using the up/down arrows.

# Troubleshooting

Problem	Cause	What to Do
Power does not turn-on	Dead battery	Charge the battery, replace battery
Power turned off automatically	Master device can't be found	Turn on Master unit
Power doesn't turn off	Program Error	Press reset button on the back of device (DLT only)
No audio or wrong audio in headphones	Disconnection of headphone	Check headphone connection
	Master unit shut off	Turn on / set Master
	Different Group Number settings	Set every unit to the same group number
	Out of range	Move to within the range of 100ft (outside) or 200 ft (inside) from the Master unit
	More than 1 Master exists in a group	Set one Master per group
	Obstacle exists	Move to another place or move the obstacles
	More than 2 units with same address exist in a group	Set different address
Error in attendee checking	More than 2 units with same address exist in a group	Set different address
Can't select receiving channel	Transmitting channel is overlapping	Set different transmitting channel
Can't select group/channel on receiver	Receiver is locked	See "Locking the DLT Buttons and Screen" on page 6
Unable to transmit Interpretation	Check the mode for simultaneous interpretation mode	Set simultaneous interpretation mode
	More than 2 Master units exist	Set one Master only
DLT keeps turning off	Master unit shut off	Turn on / set Master
Can't hear the speaker	Mic Sensitivity too low	Adjust the sensitivity for the microphone you have. (Mic 044-2p is about 33, Mic 068 is about 17).
	Master unit shut off	See why the Master shut off and correct the problem. Turn on the Master and verify the battery level.
A DLT will not sync to Master 1	Out of Range	Bring the unit closer to the Master
	Master is Off	Turn Master unit on
	Master is adjusting settings	On Master, exit settings.
	No/Incorrect Secure Code	Make the secure code the same as the Master
	Wrong Group Number	Make group numbers match the Master
Signal Strength is blinking	The Guest has not found a Master to sync to.	Program at least one unit as the Master or turn on the existing Master. Verify that the Group numbers match. Master must not be in settings menu.
Buttons not functioning	Super lock enabled	Disable super lock
Time of Day Incorrect	Time of Day on Master 1 is Incorrect. (All units sync their time from Master 1)	Set time of day to the correct time on Master 1.

## Specifications - DLT 400, DLT 400-AIM, & DLT 400-ACM Transceiver

<b>Dimensions</b>	2.60"W x 4.22"H x 0.50"D (66 mm x 107.3 mm x 12.6 mm)
<b>Weight</b>	3.3 oz (94 g) including battery
<b>Color</b>	Black/Silver (Front/Back)
<b>Case Material</b>	Black ABS plastic
<b>Battery type</b>	Lithium Polymer with smart charge built into transceiver; 1800 mAh
<b>Battery life</b>	Up to 16 hrs talk time per charge@ 1ch Tx and 1ch Rx
<b>Power Save</b>	Auto Sleep Mode after 5 minutes of no RF signal from compatible devices
<b>Charge time</b>	5 hrs. approx.
<b>System Voltage</b>	OLED 14VDC; RF 5VDC; Logic 3.3 VDC
<b>Operating frequencies</b>	2.4 GHz (ISM band); 2402 – 2476 MHz FHSS
<b>Audio Frequency response (-3dB Level)</b>	INT24, Q&A INTP, ADV. Comms, Intercom and Court Mode: 100 - 7,200 Hz Other Modes: 100 - 11,500 Hz
<b>SNR</b>	73 dB (A-weighted, default Rx volume with mic input )
<b>THD</b>	0.1 % (Default Volume, 1kHz)
<b>Microphone input</b>	Internal microphone (disabled when MIC jack engaged) and 3.5 mm phone jack (sleeve) with electret microphone bias, adjustable gain with 63dB range.
<b>Line Input</b>	USB-C, Adjustable level
<b>Headphone Output</b>	3.5 mm TRRS headphone jack; 25 mW, R 32 $\Omega$
<b>Audio Output</b>	Headphone: Max SSPL 90 111.8dB (EAR 013), 116.8dB (EAR 041) Line: USB-C, Adjustable level
<b>Range</b>	Up to 900 ft (274 m) (depending upon environmental conditions)
<b>Modulation</b>	FSK
<b>RF Output</b>	19 dBm Typical
<b>Security</b>	87 bit encryption (300 Series Compatible), 87+128 bit Encryption, Encryption PIN, Lock for settings
<b>Side tone</b>	-6 dB below volume, tone variation (Off, Low and High settings available)
<b>Indicators</b>	OLED
<b>LEDs</b>	Red LED around Talk button when enabled; Bi-color, changing green and red LED at top
<b>Charging Connectors</b>	USB-C; Two contacts for use with CHG 412
<b>Compatible Receiver</b>	DLR 400 RCH, DLR 400 ALK, DLT 300 with some limitations and DLR 360 with some limitations
<b>Operating Temperature Range</b>	14° to 113°F (-10° to 45°C)
<b>Approvals</b>	FCC, Industry Canada, CE, RoHS 3, WEEE, RCM, ANATEL, KC, Giteki
<b>Warranty</b>	2 years parts and labor (90 days on accessories); 1 year on internal battery

**NOTE: SPECIFICATIONS SUBJECT TO CHANGE WITHOUT NOTICE.**

## Specifications - DLR 400 RCH Receiver

<b>Dimensions</b>	2.60"W x 4.22"H x 0.50"D (66 mm x 107.3 mm x 12.6 mm)
<b>Weight</b>	3.3 oz (94 g) including battery
<b>Color</b>	Black
<b>Battery type</b>	Lithium Polymer with smart charge built into transceiver; 1800 mAh
<b>Battery life</b>	Up to 32 hrs per charge @ 1ch Rx
<b>Power Save</b>	Auto Sleep Mode after 5 minutes of no RF signal from compatible devices
<b>Charge time</b>	5 hrs. approx.
<b>System Voltage</b>	OLED 14VDC; RF 5VDC; Logic 3.3 VDC
<b>Operating frequencies</b>	2.4 GHz (ISM band); 2402 – 2476 MHz FHSS
<b>Audio Frequency response (-3dB Level)</b>	Intercom Mode, Court, Mode, INTP24 Mode, Q&A INTP: 100 - 7,200 Hz Other Modes: 100 - 11,500 Hz
<b>SNR</b>	73 dB (A-weighted)
<b>THD</b>	0.1 % (Default Volume, 1kHz)
<b>Headphone Output</b>	3.5 mm TRRS headphone jack; 25 mW, R32 $\Omega$
<b>Line Audio Output</b>	USB-C, Adjustable level
<b>Range</b>	Up to 900 ft (274 m) (depending upon environmental conditions)
<b>Modulation</b>	FSK
<b>RF Sensitivity</b>	-92 dBm
<b>Security</b>	87 bit encryption (300 Series Compatible), 87+128 bit Encryption, Encryption PIN, Lock for settings
<b>Indicators</b>	OLED
<b>LEDs</b>	Bi-color, changing green and red LED at top
<b>Charging Connectors</b>	USB-C; Two contacts for use with CHG 412
<b>Compatible Units</b>	DLT 400, DLT 300 with some limitations
<b>Operating Temperature Range</b>	14° to 113°F (-10° to 45°C)
<b>Approvals</b>	FCC, Industry Canada, CE, RoHS 3, WEEE, RCM, ANATEL, KC, Giteki
<b>Warranty</b>	2 years parts and labor (90 days on accessories); 1 year on internal battery

**NOTE: SPECIFICATIONS SUBJECT TO CHANGE WITHOUT NOTICE.**

## Specifications - DLR 400 ALK Receiver

<b>Dimensions:</b>	2.36" W x 3.54" H x 0.63" D (60 mm x 90 mm x 16 mm)
<b>Weight:</b>	1.7 oz. (47 g) without batteries.
<b>Frequency Band:</b>	2.4 GHz (ISM band)
<b>Modulation:</b>	FSK
<b>Case Material:</b>	Black ABS Plastic
<b>Battery Type:</b>	2 x AAA Alkaline Batteries
<b>Battery Life:</b>	Alkaline Disposable (BAT 010-2): Up to 30 hrs
<b>Power Save:</b>	Auto Sleep Mode after 5 minutes of no RF signal from compatible devices
<b>Audio Frequency Response: (-3dB level)</b>	Intercom Mode: 100 – 7,300 Hz Interpretation and other modes: 100-11,200 Hz
<b>SNR:</b>	74 dB (A-weighted)
<b>THD:</b>	0.1% (typical)
<b>Antenna:</b>	Internal
<b>Range:</b>	Up to 900 ft (274 m) (depending upon environmental conditions)
<b>Headphone Audio Output:</b>	3.5 mm TRRS jack with mono output for headphones, earphones, or neckloop 27 mW maximum @32Ω
<b>Display:</b>	LCD shows status: Battery Level, RSSI, Group/Channel #
<b>Temp. Range:</b>	14° – 113°F (-10° to 45°C)
<b>Compatible Units</b>	DLT 400, DLT 300
<b>Approvals:</b>	FCC, Industry Canada, RoHS 3, CE, WEEE, RCM, ANATEL, KC, Giteki
<b>Warranty:</b>	2 years parts and labor (90 days on accessories)

**NOTE: SPECIFICATIONS SUBJECT TO CHANGE WITHOUT NOTICE.**

# Regulatory Statements

---

## FCC

*FCC ID: CNMDLT400*

### FCC Compliance Statement

This equipment has been tested and found to comply with the limits for a Class B digital device, pursuant to Part 15 of the FCC Rules.

These limits are designed to provide reasonable protection against harmful interference in a residential installation.

This equipment generates, uses and can radiate radio frequency energy and, if not installed and used in accordance with the instructions, may cause harmful interference to radio communications. However, there is no guarantee that interference will not occur in a particular installation. If this equipment does cause harmful interference to radio or television reception, which can be determined by turning the equipment off and on, the user is encouraged to try to correct the interference by one of the following measures:

- Reorient or relocate the receiving antenna.
- Increase the separation between the equipment and receiver.
- Connect the equipment into an outlet on a circuit different from that to which the receiver is connected.
- Consult the dealer or an experienced radio/TV technician for help.

This device complies with Part 15 of the FCC Rules. Operation is subject to the following two conditions:

1. This device may not cause harmful interference, and
2. This device must accept any interference received, including interference that may cause undesired operation.

**Caution:** Any changes or modifications to the equipment not expressly approved by the party responsible for compliance could void your authority to operate the equipment.

### SAR Requirement

This equipment complies with FCC radiation exposure limits set forth for an uncontrolled environment.

This product meets the applicable national or international RF exposure guidance (SAR guideline) when used normally against your head or, when worn or carried, at a distance of 0.5 cm from the body. The SAR guideline includes a considerable safety margin designed to assure the safety of all persons, regardless of age and health.

## ISED

*IC ID: 1360A-DLT400*

### Innovation, Science and Economic Development Canada Statement

This equipment complies with IC RSS-102 radiation exposure limits set forth for an uncontrolled environment.

Operation is subject to the following two conditions:

1. this device may not cause harmful interference, and
2. this device must accept any interference received, including interference that may cause undesired operation

Cet équipement est conforme aux limites d'exposition de rayonnement d'IC RSS-102 déterminées pour un environnement non contrôlé. Cet

Son utilisation est soumise aux deux conditions suivantes:

1. Cet appareil ne doit pas causer d'interférences et
2. il doit accepter toutes interférences reçues, y compris celles susceptibles d'avoir des effets indésirables sur son fonctionnement.

## SAR Requirement

This product meets the applicable national or international RF exposure guidance (SAR guideline) when used normally against your head or, when worn or carried, at a distance of 0.5 cm from the body. The SAR guideline includes a considerable safety margin designed to assure the safety of all persons, regardless of age and health.

Ce produit est conforme aux directives nationales ou internationales sur l'exposition aux fréquences radioélectriques (directives SAR) en vigueur lorsqu'il est utilisé normalement contre la tête ou, porté ou porté, à une distance de 0,5 cm du corps.

La directive SAR inclut une marge de sécurité considérable conçue pour assurer la sécurité de toutes les personnes, indépendamment de leur âge et de leur santé.

## Declaraciones Mexicanas

### Referente a la disposición técnica IFT-008-2015

La operación de este equipo está sujeta a las siguientes dos condiciones: (1) es posible que este equipo o dispositivo no cause interferencia perjudicial y (2) este equipo o dispositivo debe aceptar cualquier interferencia, incluyendo la que pueda causar su operación no deseada.

## European Union

Hereby, Williams AV declares that the transceiver is in compliance with Directive 2014/53/EU and other Union harmonization as applicable. The full text of the EU declaration of conformity is available by contacting Williams AV at the following email address: [regulatory@williamsav.com](mailto:regulatory@williamsav.com)

## Japanese Statements



この装置は、クラスA機器です。この装置を住宅環境で使用すると電波妨害を引き起こすことがあります。この場合には使用者が適切な対策を講ずるよう要求されることがあります。VCCI-A

This is a Class A equipment. Operation of this equipment in a residential environment could cause radio interference. In such a case, the user may be required to take corrective actions.  
VCCI-A



R 210-133739

## Korean Identification Numbers



R-C-WSa-DLT400  
R-R-WSa-DLR400RCH

## Brazilian Statements

These units have been tested and certified by an independent party, Anatel, in Brazil.



**ANATEL: 08891-19-09817**

**Este equipamento não tem direito à proteção contra interferência prejudicial e não pode causar interferência em sistemas devidamente autorizados.**



## 2-Year Warranty

---

Williams AV products are engineered, designed, and manufactured under carefully controlled conditions to provide you with many years of reliable service.

Williams AV warrants the Digi-Wave system against defects in materials and workmanship under normal use and conditions for 2-years from the product's date of purchase.

This warranty is available to the original end purchaser of the product and CAN BE transferred to subsequent purchasers of the product.

The internal battery for DLT 400 (and variants) and DLR 400 RCH carries a one year warranty. Microphones, earphones, headphones, alkaline batteries, chargers, cables, carry cases, and most other accessory products carry a 90-day warranty.

Williams AV has no control over the conditions under which this product is used. Williams AV, therefore, disclaims all warranties not set forth above, both express and implied, with respect to the Digi-Wave System, including but not limited to, any implied warranty of merchantability or fitness of use of such equipment including, without limitation, any warranty that the use of such equipment for any purpose will comply with applicable laws and regulations. Williams AV shall not be liable to any person or entity for any medical expenses or any direct, incidental or consequential damages caused by any use, defect, failure or malfunctioning of the product, whether a claim for such damages is based upon warranty, contract, tort or otherwise.

The sole remedy for any defect, failure or malfunction of the products is replacement of the product. No person has any authority to bind Williams AV to any representation or warranty with respect to the Digi-Wave System. Unauthorized repairs or modifications will void the warranty. This warranty is void if damage occurred because of misuse, or if the product has been repaired or modified by anyone other than a factory authorized service technician. Warranty does not cover normal wear and tear on the product or any other physical damage unless the damage was the result of a manufacturing defect. Williams AV is not liable for consequential damages due to any failure of equipment to perform as intended. Williams AV shall bear no responsibility or obligation with respect to the manner of use of any equipment sold by it.

This warranty does not cover reimbursement for your costs of removing and transporting the product for warranty service evaluation or installation of any replacement product provided under this warranty.

The exclusions and limitations set out above are not intended to, and should not be construed so as to contravene mandatory provisions of applicable law. If any part or term of this Disclaimer of Warranty is held to be illegal, unenforceable, or in conflict with applicable law by a court of competent jurisdiction, the validity of the remaining portions of this Disclaimer of Warranty shall not be affected, and all rights and obligations shall be construed and enforced as if this warranty did not contain the particular part or term held to be invalid. The terms of the warranty are governed by the laws of the State of Minnesota.

Prices and the specifications of the products are subject to change without notice.

For Complete Warranty Statement go to: [www.williamsav.com/warranty-statement](http://www.williamsav.com/warranty-statement)

NOTICE: Williams AV products are NOT designed for use in extreme temperature, humidity or chemical environments. The introduction of chemicals such as chlorine, salt water or human sweat into the product will cause damage to the circuitry. Damage due to these causes is NOT covered under the Product Warranty.

If you experience difficulty with your system, call Toll-Free for Customer Assistance

**1-800-843-3544 (U.S.A.) or +1 952 943 2252 (Outside the U.S.A.)**

If it is necessary to return the system for service, your Customer Service Representative will give you a Return Authorization Number (RA) and shipping instructions.

Pack the system carefully and send it to:

**Williams AV  
Attn: Repair Dept.  
10300 Valley View Road  
Eden Prairie, MN 55344**

This page intentionally left blank.